

CANISTERIZED SATELLITE DISPENSER

DATA SHEET | 2002337G

spacesystems@rocketlabusa.com
rocketlabusa.com

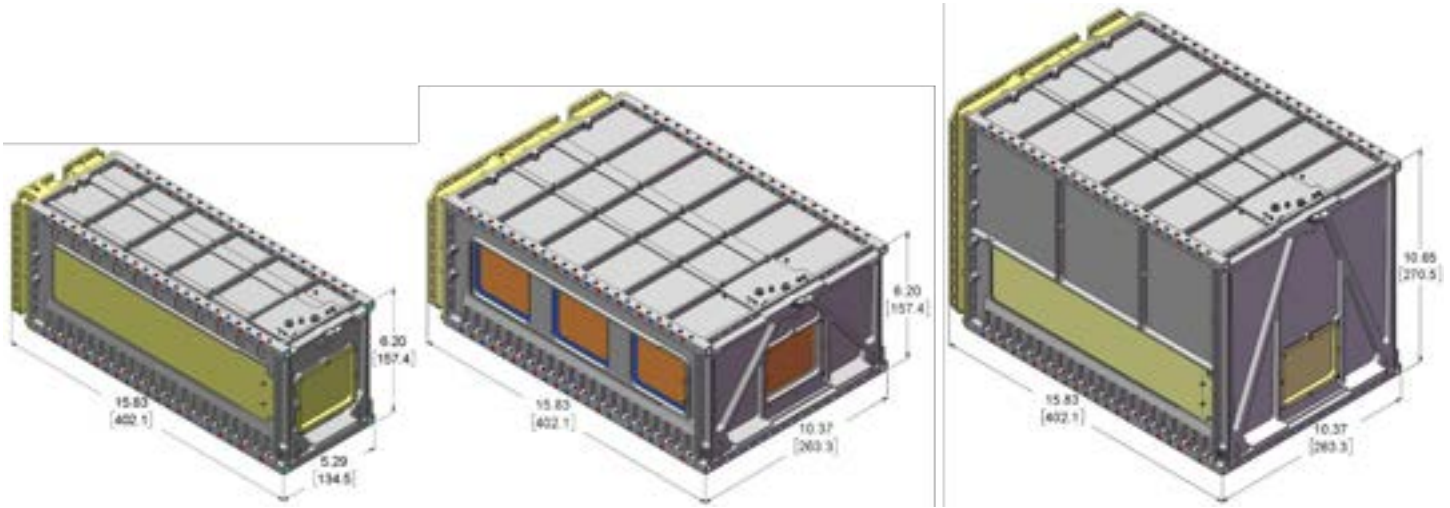



3U, 6U and 12U CSDs. 6U shown with access panels removed. Dimensions in inches [mm].

Feature	Benefit
Preloaded Payload Tabs	Preload means the payload can't jiggle and damage itself . Creates a modelable load path to the payload so strength at critical locations like reaction wheel bearings can be accurately calculated.
Low Tip-Off	Payloads stabilize rapidly . Precision tabs, roller bearings and a linear way combine to minimize disturbance torques.
Six Mountable Sides	Greatly reduces the cost, complexity and mass of adjoining structures and interface plates to the launch vehicle.
Motor Driven Initiator	Creates the lowest cost, most reliable dispensing mechanism that resets in seconds without consumables.
Robust Structural Design	Withstands extreme shock, vibration and thermal environments.
Payload Electrical Connector	Allows communication and charging between payload and launch vehicle prior to and during launch.
Conductive External Surfaces	Prevents surface charging .
CSD-Constrained Deployables	Greatly reduces the cost and complexity of payload deployables like solar panels and antennas by using the CSD's internal walls to constrain instead of burn wires.
Complete Payload Separation	Demonstrates whole system reliability during testing.
Manual Door Release	Allows the CSD to be operated without electrical interface .
P-Pod Compatible Mounting Interface	Ensures compatibility with existing structures .
Full Length, Constant-Force Ejection Spring	Ensures positive, constant force margin throughout ejection.
Lowest External Volume	Increases packaging density on launch vehicle.
Largest Internal Volume	Payloads have 15% more volume and can be 1 inch longer than standard CubeSats.
Safe/Arm Access on Front Door	Ensures access to payload at all times.
Flight Validated	Attained TRL 9 with flight heritage in 2013.
Reverse Polarity Protection	Ensures deployment even if electrical polarity is reversed.
State Switches	Indicate door state, payload occupancy and dispensing velocity .
Electrically Redundant	Two independent circuits and a triple redundant commutator ensure deployment .
Fully Documented	Mechanical and electrical interfaces and CAD models available for download allowing rapid and low-cost design .
Parametric Design	Commonality allows users easy understanding of electro-mechanical interface for 3U, 6U and 12U sizes.
Lowest Cost	Reduced mission cost through simplified design, test and integration.

Payload Compatibility: The CSD is compatible with payloads that meet current payload specification 2002367 Rev F (ref. 3) and the prior revisions 2002367 Rev C, D & E.

CSD Compatibility: CSD's built to this rev G Data Sheet also comply with the Rev E Data Sheet and vice versa.

U.S. Patent 9,415,883 B2

TABLE OF CONTENTS

1.	Flight Heritage	4
2.	Description	5
3.	Benefits of Preloaded Tabs	6
4.	Parameters	10
5.	Mechanical Interface	11
6.	Electrical Interface	14
7.	Electrical Schematic	15
8.	Initiation Electrical Profiles	17
9.	Maximize Telemetry	18
10.	Ejection Plate Resistance	19
11.	Payload in CSD	20
12.	Environmental Testing	21
13.	CSD-Generated Shock	27
14.	Micro-Gravity Flight	29
15.	Payload Ejection.....	31
16.	Door Bounce	33
17.	Allowable Payload Response.....	36
18.	Tab Gaps & Discontinuities	37
19.	Payload Volume	38
20.	Operation and Integration	39
21.	CSD Constrained Deployables	41
22.	Fastening Payload to Ejection Plate	42
23.	Reducing Dynamic Loading on Payload	45
24.	CSD Applications	47
25.	Test Support Equipment	57
26.	Specifying and Ordering.....	59
27.	Typical Lead Time	59
28.	Cost	59
29.	Training	59
30.	Reliability	60
31.	Failure Modes and Effects Analysis	61
32.	Storage Requirements	61
33.	Tips and Considerations	62
34.	Acknowledgements	62
35.	CAD and Finite Element Models	62
36.	References	63
37.	Additional Information	63
38.	Revision History	64

1. FLIGHT HERITAGE

The CSD is at Technology Readiness Level (TRL) 9. A 3U CSD flew aboard the inaugural Falcon 9 v1.1 flight on September 2013 and released the 7-piece POPACS payload in orbit. See ref. 6. Also see www.planetarysys.com for up to date flight heritage.



Figure 1-1: Integration of POPACS mission (Ref. 2, 6)

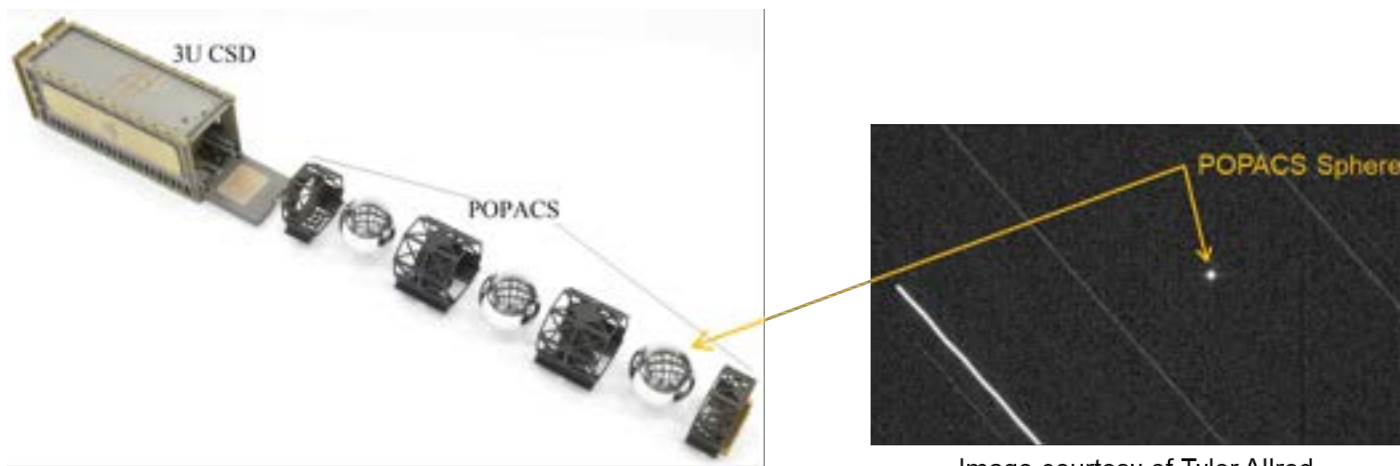

Image courtesy of Tyler Allred

Figure 1-2: POPACS satellite and on-orbit image

2. DESCRIPTION

The Canisterized Satellite Dispenser (CSD) is a reliable, testable, and cost-effective deployment mechanism for small secondary or tertiary payloads. It fully encapsulates the payload during launch and thus provides mission assurance for both the primary payload and launch vehicle (LV). All material in the primary load path are MSFC-STD-3029 Table I for stress corrosion cracking. All external surfaces are electrically conductive chem-film or nickel-plated aluminum alloy. The CSD is not ESD sensitive. This data sheet encompasses 3U, 6U and 12U CSDs.

The CSD is easy to use and operate. The act of closing its door automatically preloads the payload tabs. There are no pyrotechnics. The door initiator is a DC brush motor with substantial flight heritage. The initiator is open-loop, meaning that no feedback is required. The CSD can be cycled in a matter of seconds without consumables. The motor, an excellent torque transducer, provides invaluable feedback to the health of the mechanism by monitoring voltage and current during each operation.

The CSD has unique features that allow mounting to any face. This reduces the necessity for heavy interface structures and allows the CSDs to be densely packaged on the launch vehicle. It also contains an optional Separation Electrical Connector to the payload.

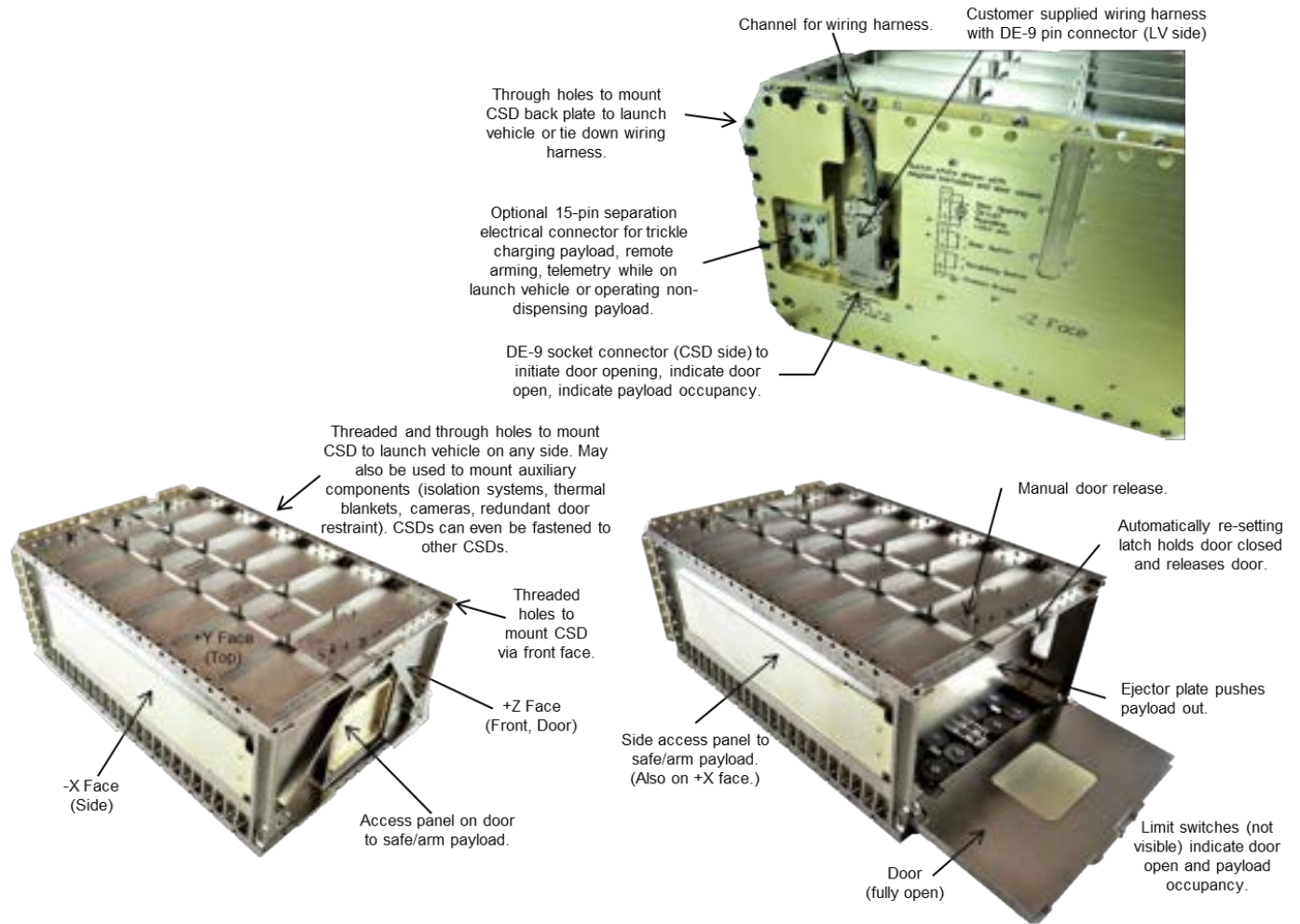

Figure 2-1: CSD features (6U shown)

3. BENEFITS OF PRELOADED TABS

Preloading the payload to the CSD by virtue of clamping the tabs creates a stiff invariant load path. This allows for accurate dynamic modeling to predict responses in anticipation of vibratory testing and space flight.

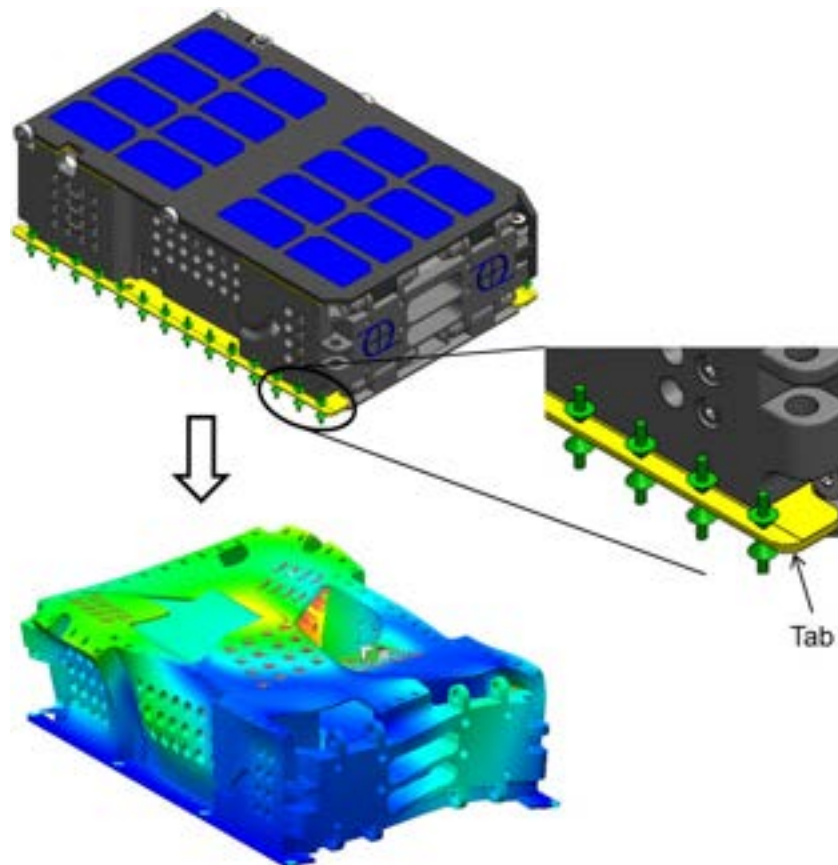

Figure 3-1: 6U payload predicted dynamic response

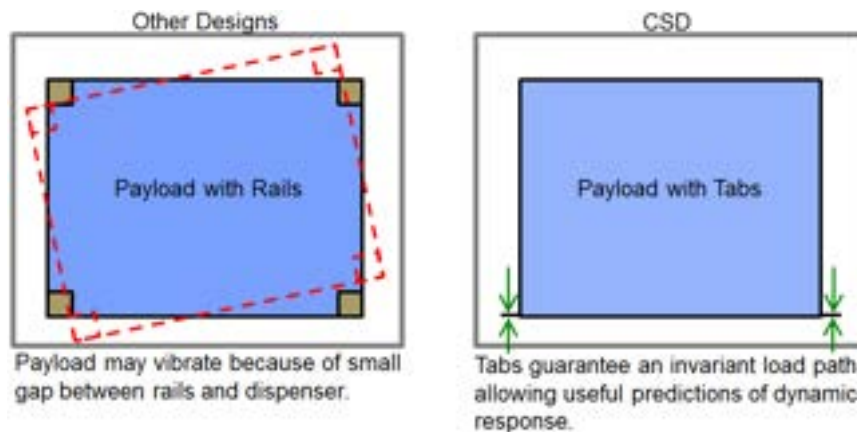

Figure 3-2: Benefit of tabs vs. rails

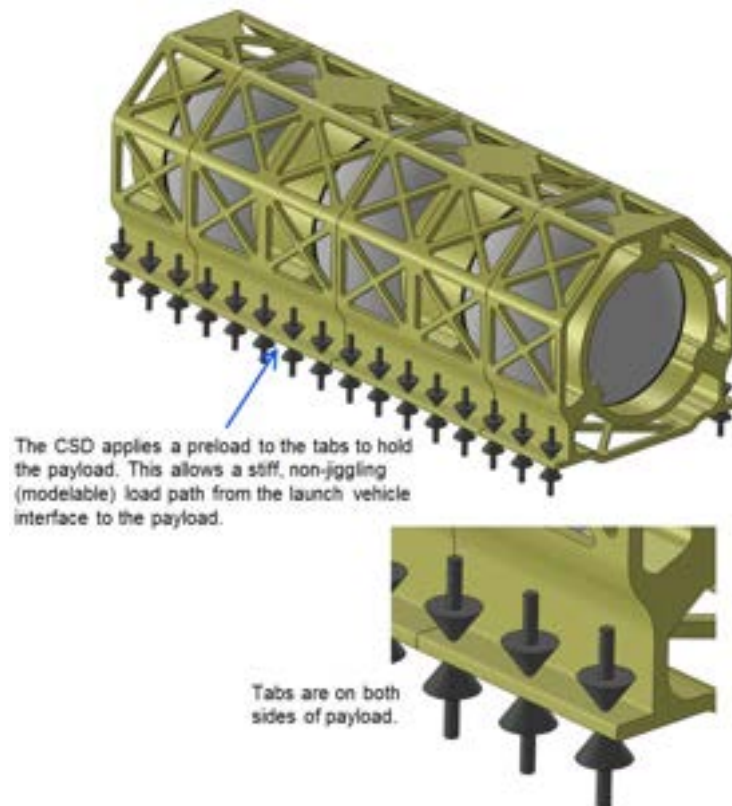
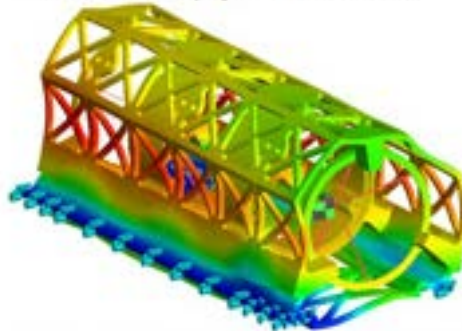

Figure 3-3: Preloaded tabs of a 3U payload (ref. 2)

First mode of payload is 1,155 Hz



First mode of CSD and payload is 508 Hz

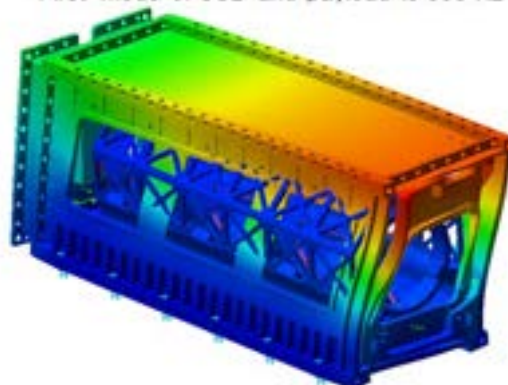

Figure 3-4: Prediction of 3U dynamic response

Preloaded tabs allow for accurate dynamic modeling that can be used to predict fatigue of structures, mechanisms, electronics, PCBs, solder junctions, etc.

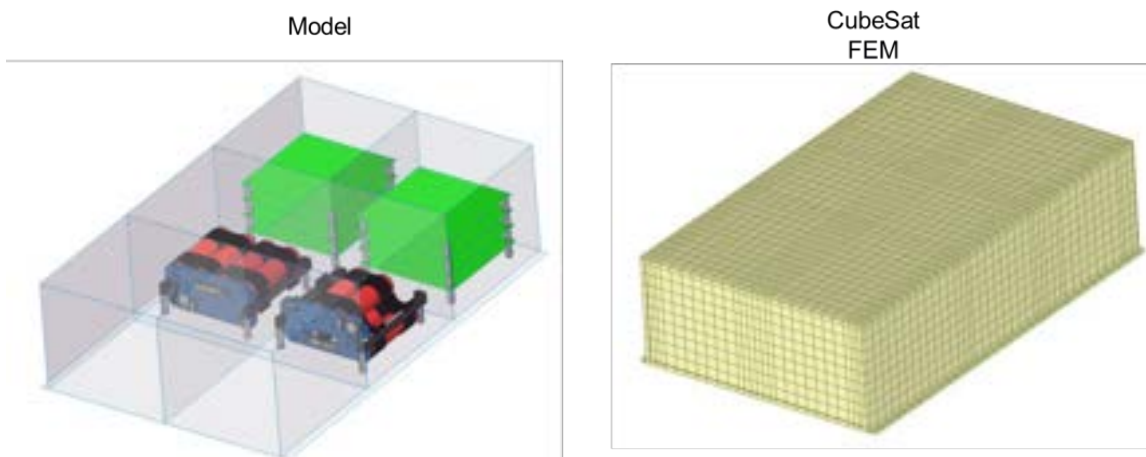

Figure 3-5: Satellite model and FEM

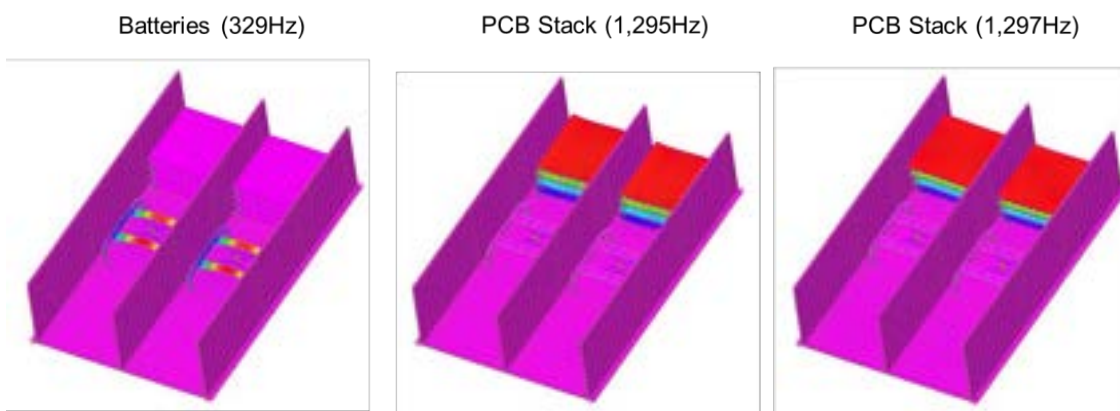

Figure 3-6: Normal modes analysis of satellite elements

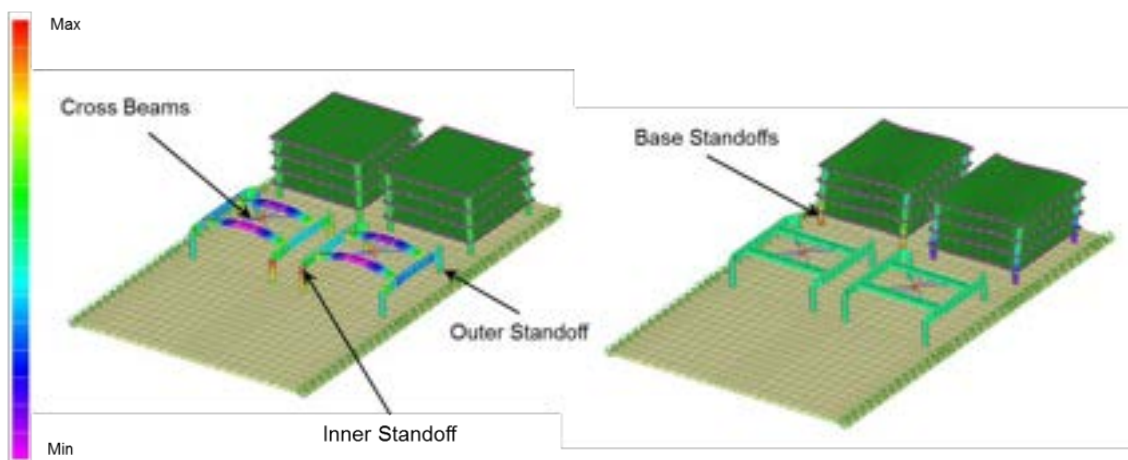

Figure 3-7: Identifying components with high strain

The CSD's unique ability to preload tabs attached to the payload guarantees a stiff, invariant load path from launch vehicle to payload. In the sine burst profile below, the input to the CSD is transferred through the tabs to the payload, verifying that there is no slipping or jiggling within the system.

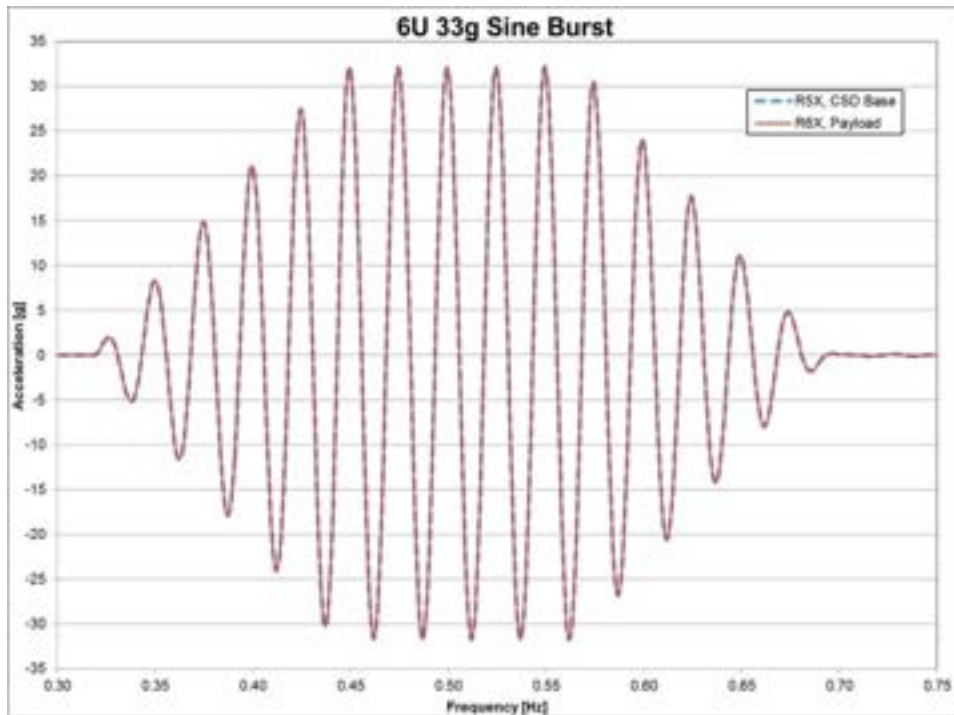

Figure 3-8: Actual payload and CSD response during a sine burst test

Preloaded tabs allow designers to accurately model and predict their payload response with high confidence. The sine sweep profiles below demonstrate no change in load path (slipping) from the CSD to the payload after sine burst and random vibration exposure.

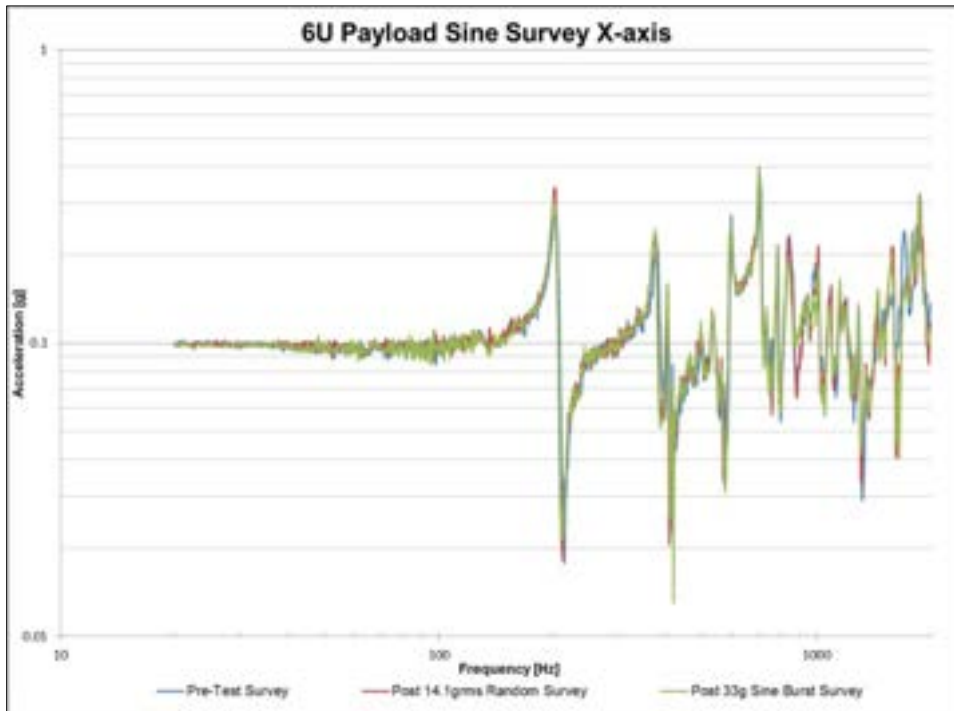

Figure 3-9: Actual payload sine sweeps

4. PARAMETERS

Table 4-1: Parameters

Doc. Sec.	Symbol	Parameter	Conditions	Units	3U		6U		12U	
					Min	Max	Min	Max	Min	Max
-	-	PSC Assembly Number		-	4000744		4000745		4000746	
-	M	Mass (1)	Empty. ±3%	lb [kg]	7.33 [3.32]		9.93 [4.50]		12.46 [5.65]	
5	Height	Height, +Y		in [mm]	6.187 [157.15]	6.207 [157.66]	6.187 [157.15]	6.207 [157.66]	10.640 [270.26]	10.660 [270.76]
5	Width	Width, ±X		in [mm]	5.285 [134.24]	5.305 [134.75]	10.355 [263.02]	10.375 [263.53]	10.355 [263.02]	10.375 [263.53]
5	CM _{Xc}	Center of Mass, ±X	Door closed, ejection plate position as if payload installed	in [mm]	-23 [-5.8]	.17 [4.3]	-23 [-5.8]	.17 [4.3]	-23 [-5.8]	.17 [4.3]
5	CM _{Yc}	Center of Mass, ±Y	Door closed, ejection plate position as if payload installed	in [mm]	2.34 [59.4]	2.74 [69.6]	2.4 [61.0]	2.8 [71.1]	4.33 [110.0]	4.73 [120.1]
5	CM _{Zc}	Center of Mass, ±Z	Door closed, ejection plate position as if payload installed	in [mm]	7.59 [192.8]	7.99 [202.9]	7.43 [188.7]	7.83 [198.9]	7.28 [184.9]	7.68 [195.1]
5	CM _{Xo}	Center of Mass, ±X	Door open, payload ejected	in [mm]	-23 [-5.8]	.17 [4.3]	-23 [-5.8]	.17 [4.3]	-23 [-5.8]	.17 [4.3]
5	CM _{Yo}	Center of Mass, ±Y	Door open, payload ejected	in [mm]	2.22 [56.4]	2.62 [66.5]	2.24 [56.9]	2.64 [67.1]	3.95 [100.3]	4.35 [110.5]
5	CM _{Zo}	Center of Mass, ±Z	Door open, payload ejected	in [mm]	8.12 [206.2]	8.52 [216.4]	8.17 [207.5]	8.57 [217.7]	8.46 [214.9]	8.86 [225.0]
5	MO _{Xc}	X-Axis Mass Moment of Inertia	About CM, door closed, ejection plate position as if payload installed	lb*in ² [kg*m ²]	230 [.067]	254 [.074]	327 [.096]	362 [.106]	548 [.161]	605 [.177]
5	MO _{Yc}	Y-Axis Mass Moment of Inertia	About CM, door closed, ejection plate position as if payload installed	lb*in ² [kg*m ²]	221 [.065]	244 [.071]	410 [.120]	453 [.133]	530 [.155]	585 [.171]
5	MO _{Zc}	Z-Axis Mass Moment of Inertia	About CM, door closed, ejection plate position as if payload installed	lb*in ² [kg*m ²]	61 [.018]	67 [.020]	179 [.052]	198 [.058]	352 [.103]	389 [.114]
5	MO _{Xo}	X-Axis Mass Moment of Inertia	About CM, door open, payload ejected	lb*in ² [kg*m ²]	237 [.069]	261 [.077]	348 [.102]	385 [.113]	642 [.188]	709 [.208]
5	MO _{Yo}	Y-Axis Mass Moment of Inertia	About CM, door open, payload ejected	lb*in ² [kg*m ²]	228 [.067]	252 [.074]	429 [.126]	475 [.139]	623 [.182]	688 [.202]
5	MO _{Zo}	Z-Axis Mass Moment of Inertia	About CM, door open, payload ejected	lb*in ² [kg*m ²]	59 [.017]	65 [.019]	176 [.052]	195 [.057]	353 [.103]	390 [.114]
16	MO _b	Door's X-Axis Mass Moment of Inertia	About door hinge axis, with access panel	lb*in ² [kg*m ²]	2.3 [6.7E-4]	2.5 [7.3E-4]	5.2 [1.5E-3]	5.8 [1.7E-3]	28.0 [8.2E-3]	32.0 [9.4E-3]
14, 15	S	Quantity of Ejection Springs		-	1	2	2	4	2	4
6to9	V	Voltage Provided from Launch Vehicle to Open Door	Power to pins 1 & 2, return from pins 3 & 4	Vdc	22 to 34					
6to9	R _{DI}	Winding Resistance of Door Initiator (2)	-45 to +90 °C, includes internal CSD wiring	Ω	7.4 to 13.0					
6to9	L _{DI}	Inductance of Door Initiator	At terminals	mH	.452					
6to9	I _p	Peak Current Draw from Door Initiator (3)	<0.005 sec	A	1.7 to 4.9					
6to9	I _c	Continuous Current Draw from Door Initiator (4)		A	.10 to 1.5					
6to9	T	Time to Initiate (Open Door) (4)	-45 to +90 °C, <10e-5 torr	s	.016 (+.034/- .006)					
6to9	R _S	Switch Terminal Resistance	Door and occupancy switches, closed circuit, includes internal CSD wiring, -45 °C to +90 °C	ohm	.046 to .107					
6to9	I _{SR}	Current Capacity of Switch, Resistive	28 Vdc, <10e-5 torr, door and occupancy switches	A	2.5					
6to9	I _{SI}	Current Capacity of Switch, Inductive	28 Vdc, <10e-5 torr, door and occupancy switches	A	1.5					
15	PT	Payload Travel Required for Occupancy Switch State Change	+Z travel from launch position	in [mm]	13.27 [337.1]	13.33 [338.6]	13.24 [336.3]	13.30 [337.8]	13.24 [336.3]	13.30 [337.8]
5to9	DA	Door Opening Angle for Door Switch Change of State	Angle (0 deg is closed)	deg	.3	2.0	.3	2.0	.1	1.0
-	FEP _V	Ejection Plate Force on Payload (5, 6)	During launch due to vibration (assuming 100g response)	lbf [N]	0 [0]	22 [98]	0 [0]	43 [191]	0 [0]	86 [383]
15	FEP _S	Ejection Plate Force on Payload (6)	During separation, force per ejection spring, ±15% due to friction and spring variation	lbf [N]	2.6 [11.6]					
14, 15	PRR	Payload Rotation Rates	Per axis, after payload is fully ejected from CSD	deg/s	<10					
5	LVF	Launch Vehicle Flatness (7,8)	As a result of attaching, the LV shall not deform the CSD interface surface more than listed.	in [mm]	.005 [.13]					
-	TML	Total Mass Loss	Per ASTM E 595-77/84/90	%	<1.0					
-	CVCM	Collected Volatile Condensable Material	Per ASTM E 595-77/84/90	%	<.1					
-	DP	LV De-Pressurization Rate (7)	During launch	psi/s	<1.0					
12, 15	T _S	Survival Temperature	Qualification limits	°F [°C]	-58 to 194 [-50 to 90]					
12, 15	T _O	Operational Temperature	Qualification limits	°F [°C]	-29 to 176 [-34 to 80]					
-	L	Life	Allowable number of door closures by customer before refurbishment is required	-	50					

- Includes 1 (3U) or 2 (6U/12U) ejection springs and no separation electrical connector (in-flight disconnect). Add .05 lb for each additional ejection spring and .03 lb for the Lower Separation Connector. The tolerance accounts for machining variation of CSD components.
- Actual winding resistance can be calculated by $R_{DI} = 10.3(1+.004(\text{Temperature } [^{\circ}\text{C}]-25))$. The '10.3' is nominal room temperature tolerance. Assume ±5%.
- Actual Peak Current can be calculated by $I_p = V/R_{DI}$.
- Door Initiator will continue to draw current (I_c) until power is cut from LV. This is not detrimental to the CSD. LV may leave power on up to .5 s after door limit switch opens.
- The CSD's Ejection Plate is sandwiched between the payload and the CSD's back face when stowed. However, during vibration the Ejection Plate may resonate, causing it to repeatedly impact and gap the payload's -Z face. This force assumes a conservative 100g dynamic response of the Ejection Plate impacting the payload.
- FEP_V and FEB_S shall not be used to predict velocity. Due to door bounce and CSD friction, velocity will be lower. See Section 15 for velocity estimate.
- These are requirements imposed on the launch vehicle.
- Ensures the payload will properly eject from the CSD. If the LV interface is much stiffer than the CSD (thick plate) its flatness will need to be held to the allowable CSD deformation. Isolation systems naturally attenuate this issue.

5. MECHANICAL INTERFACE

- Dimensions apply to all CSD sizes unless the view specifically states otherwise (Ex. “3U only”).
- All external CSD mounting surfaces are 6061-T6 or 7075-T7 aluminum alloy with either chemical film per MIL-DTL-5541, Class 3, color gold/yellow or electroless nickel per ASTM B733-15 surface treatments. The colors in the images below are representative, however PSC may change specific parts without notice.
- Unless otherwise specified, tolerances are ±.010 in. for linear dimensions and ±.003 in. for hole diameters.
- The 12U external surfaces (+X, -X, +Y, -Y faces) may bow, flatness up to .030, due to internal material stresses relieved during machining. This does not affect performance. Further, it is acceptable if the surface is forced flat when bolted to an adjoining structure.
- To minimize external volume, standard #10 washers (NAS620C10) do not fit in the CSD flanges. Instead, PSC uses bearing or shoulder screw shims (McMaster-Carr PN 93574A438 or 94773A739).
- Solid models of each CSD, in STEP format, are available for download on PSC’s website. Use these to ensure proper bolt access to adjoining vehicles.
- The typical wall thickness is .060 in. However localized areas may be as thin as .030 in. This data can be useful for radiation analysis.

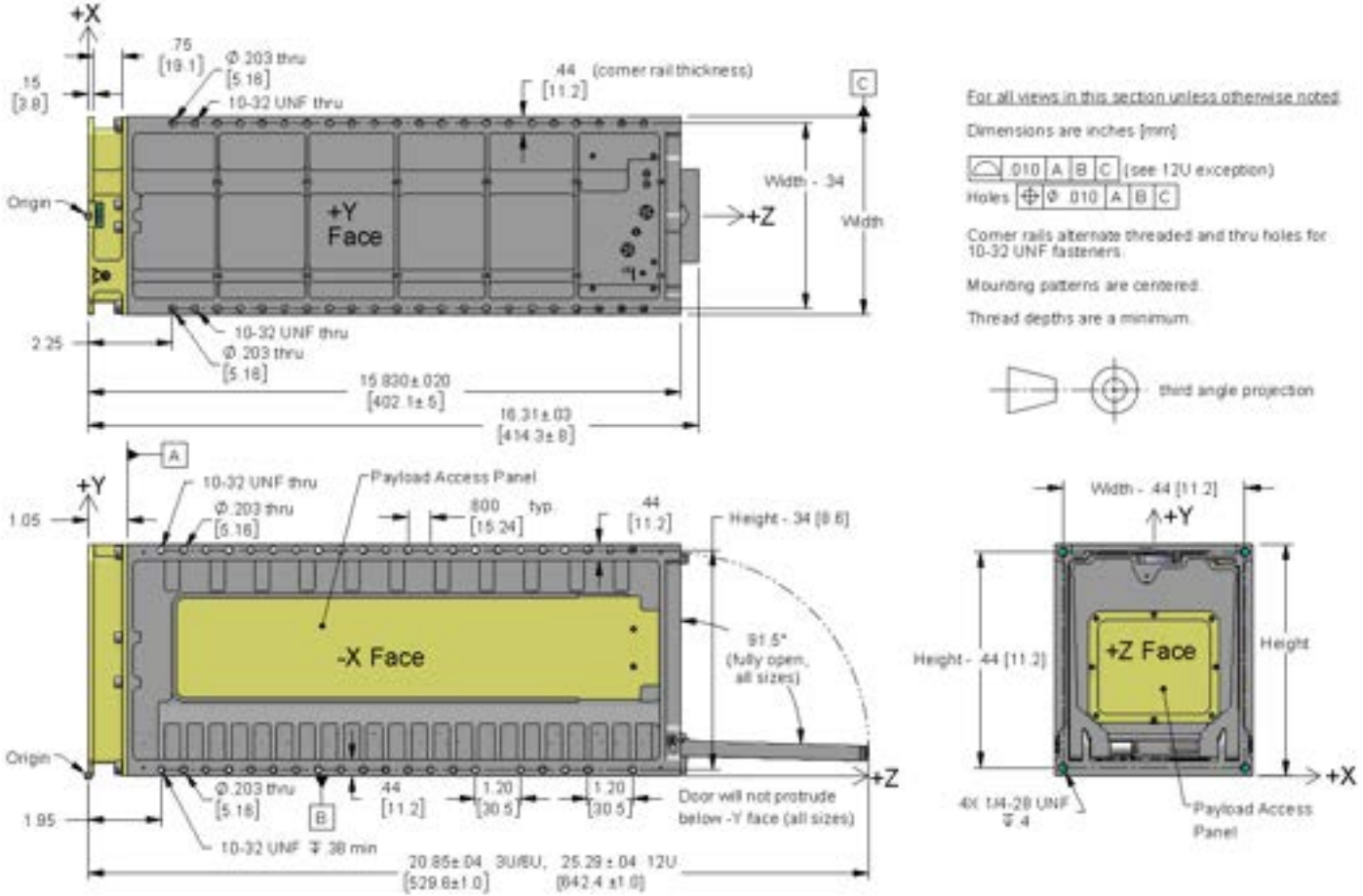

Figure 5-1: CSD mechanical interface dimensions

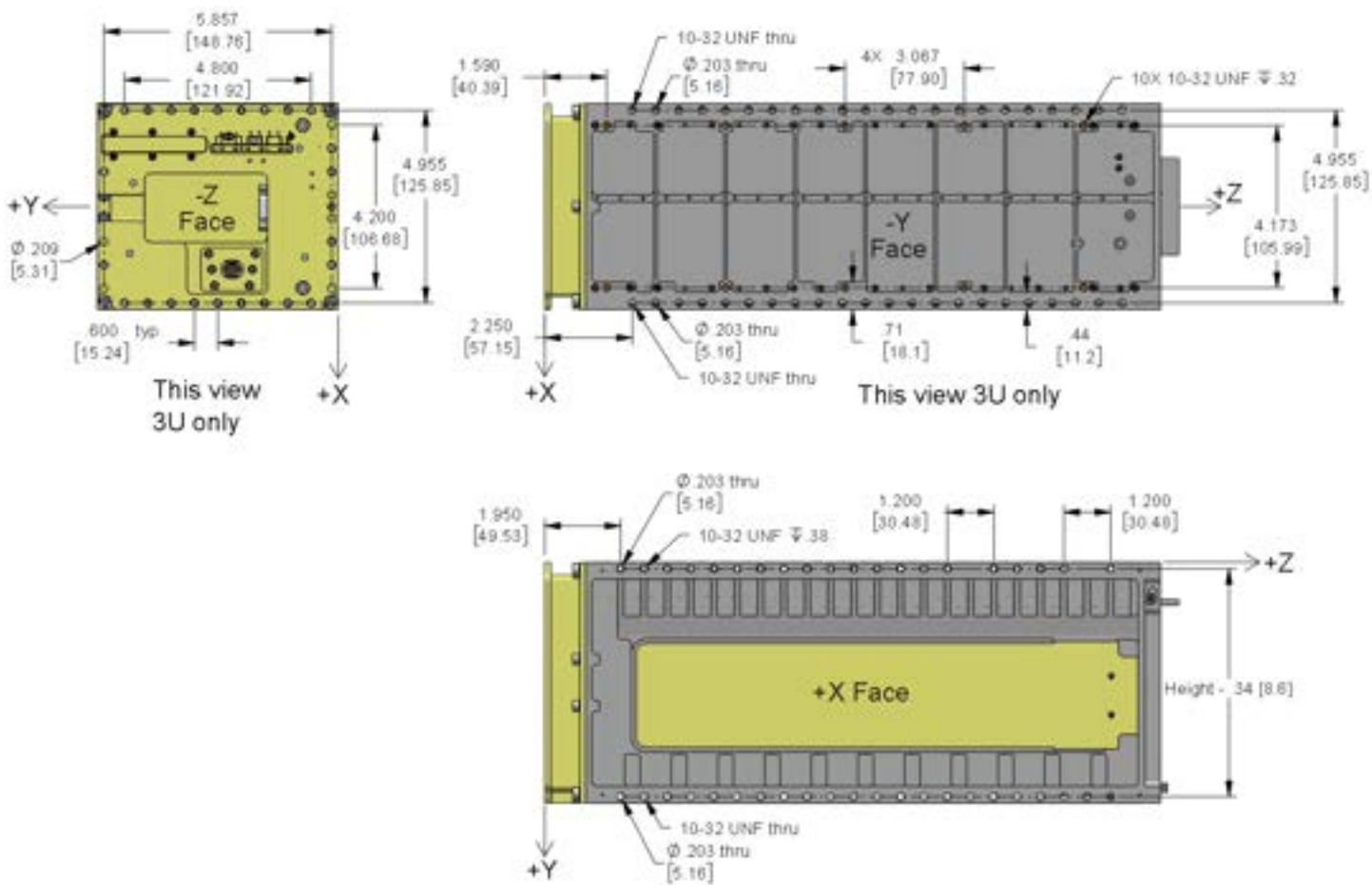

Figure 5-2: Mechanical interface dimensions (cont.). Some views unique to 3U.

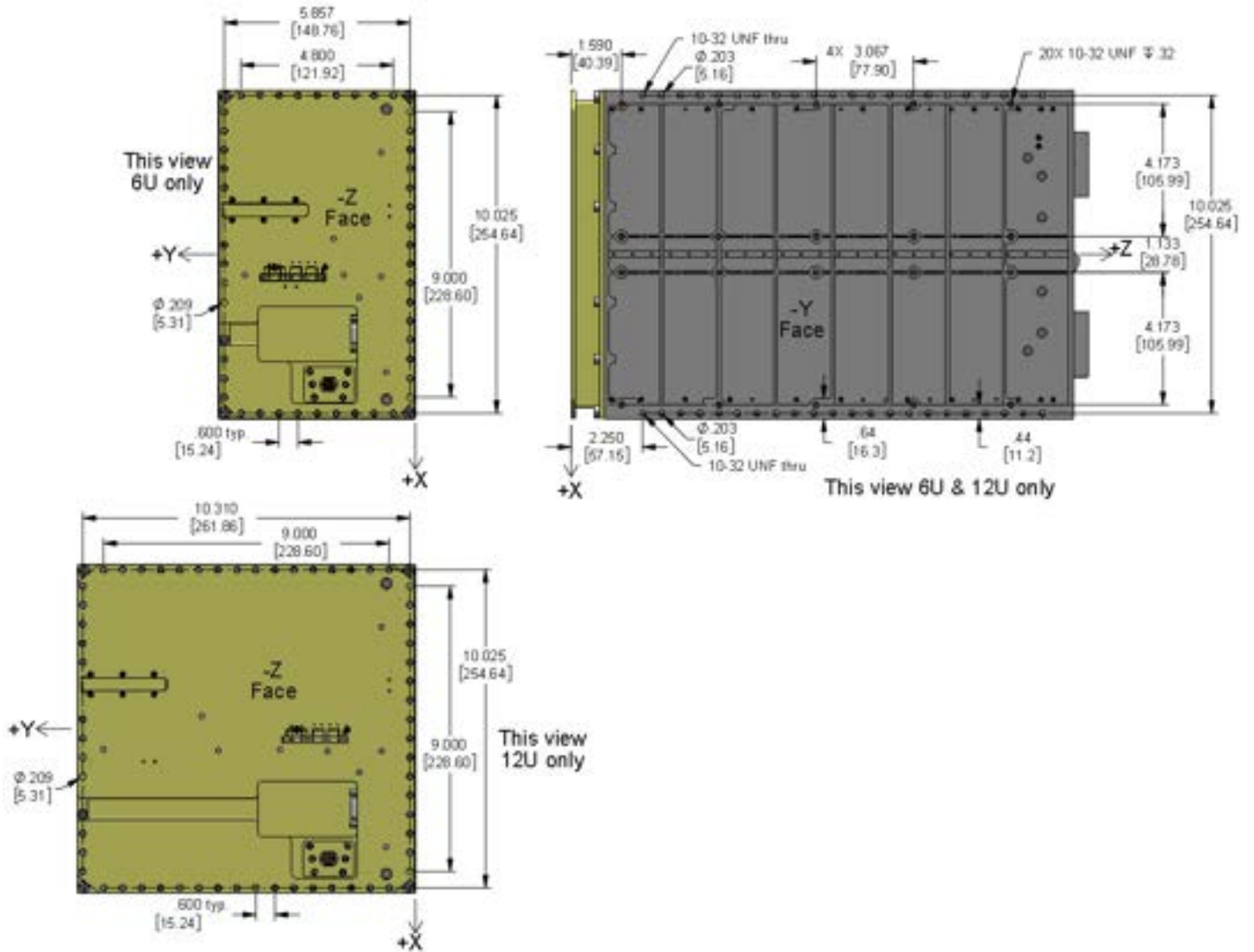

Figure 5-3: Mechanical interface dimensions unique to 6U and 12U

6. ELECTRICAL INTERFACE

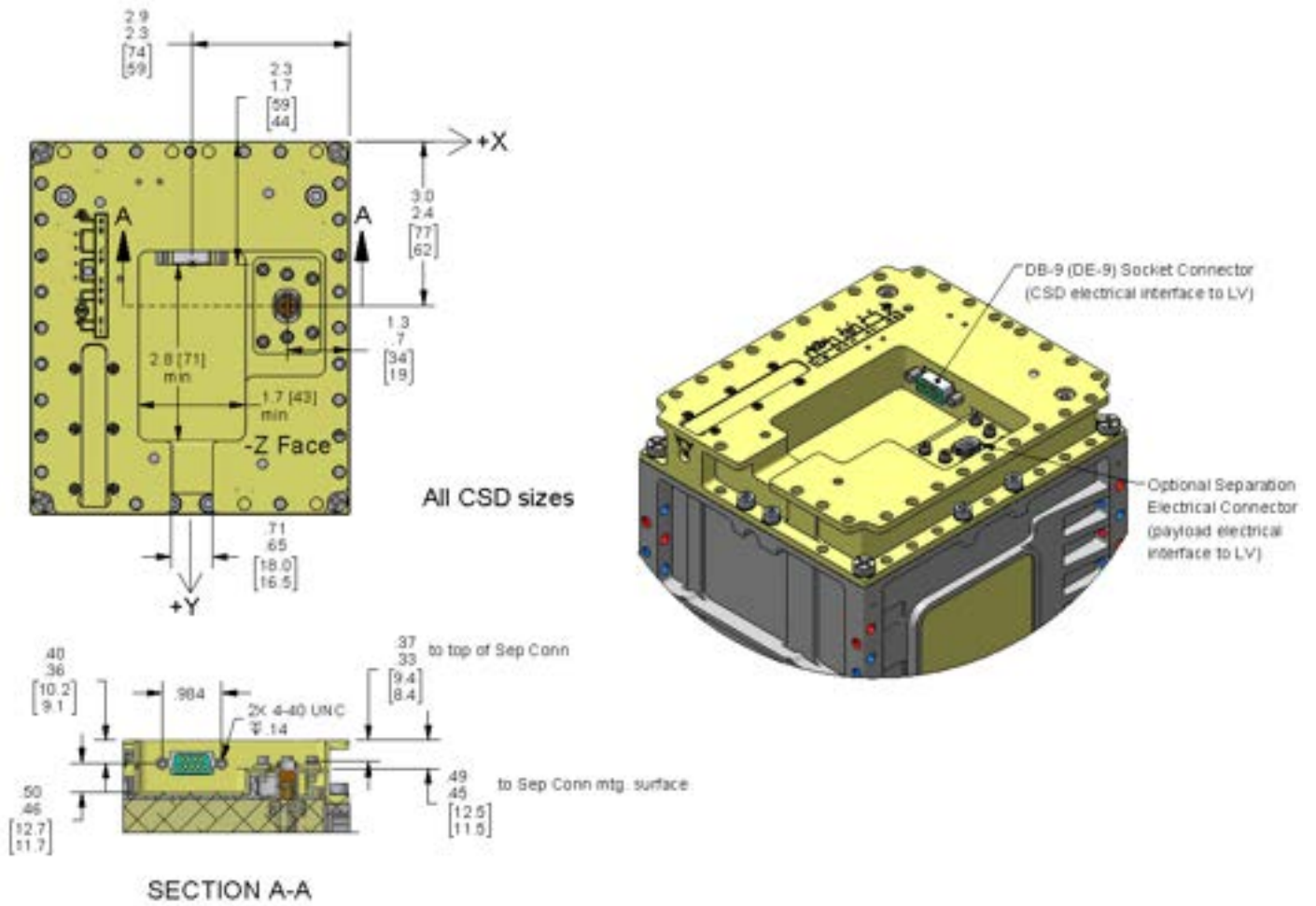
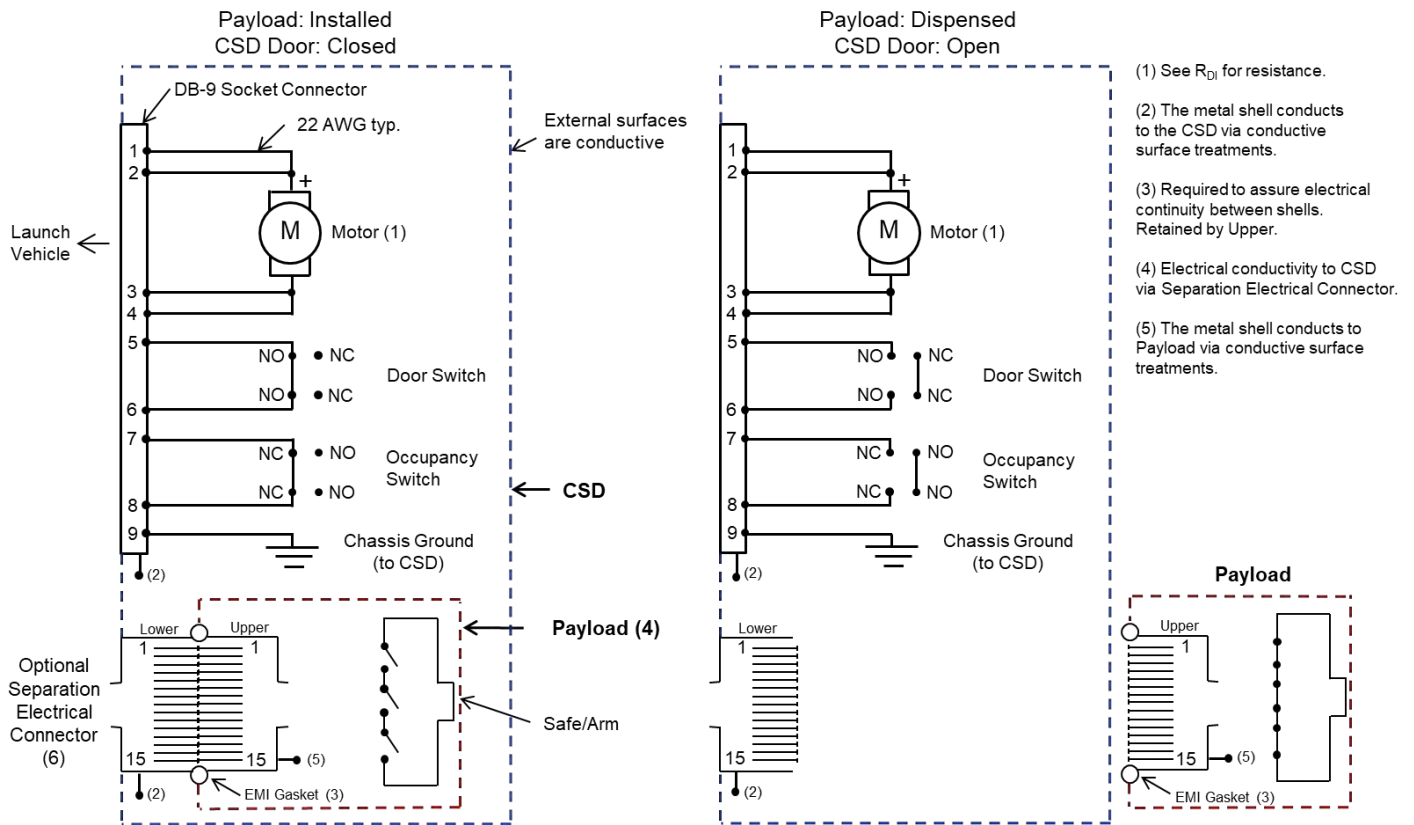

Figure 6-1: Launch vehicle electrical interface

7. ELECTRICAL SCHEMATIC



(6) The Separation Electrical Connector is an in-flight disconnect (IFD). It is a custom connector provided by PSC that has significant space-flight heritage. It can be used to transmit power or telemetry. It can also be wired as a loopback to indicate separation. The launch vehicle side of the connector must be removed from the CSD prior to the initial payload installation. It may be re-attached to the CSD after payload installation and door closure. This ensures proper alignment of the connector halves. For more information see PSC document 2001025 Separation Connector Data Sheet on PSC's website.

The Separation Connector can also be used for payload inhibits. If doing so, it is recommended to use three loop-back circuits, all of which must go open. This is due to the potential intermittencies in the pins at high shock and vibration levels. See Figure 7-2.

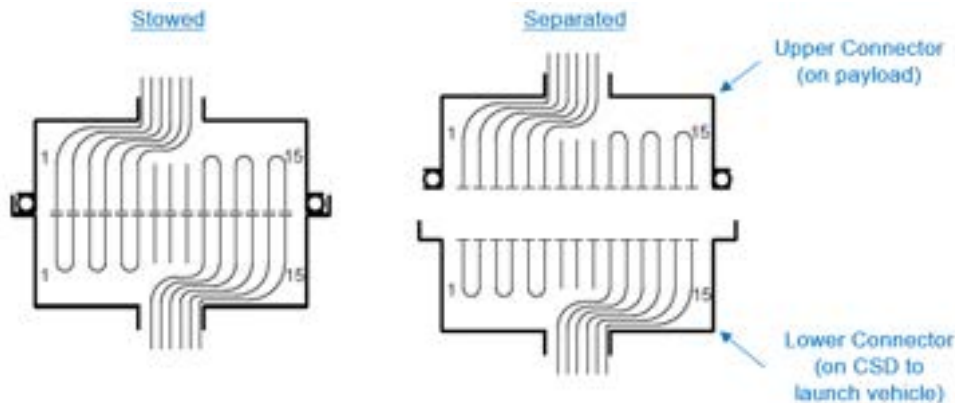

Figure 7-2: Example Separation Connector loop-back wiring

During qualification testing, PSC monitored the electrical continuity of the Separation Connector, Door Switch and Occupancy Switch. See Figure 7-3 for the circuit. The Separation Connector had 14 of its 15 pins wired in series through loopbacks.

In thermal vacuum testing all circuits remained electrically closed across all temperatures.

During shock and random vibration testing the components were monitored at ≥ 10 kHz per channel to detect intermittencies. All three items exhibit some intermittencies. The frequency and duration of the intermittencies varies with CSD size, excitation axis, mounting face and payload dynamic response. Electrical designers should be aware of these potential intermittencies to design their hardware and software accordingly. Figure 7-4 and Figure 7-5 show example intermittency during 14.1 grms random vibration. The units of time are seconds in the figures below.

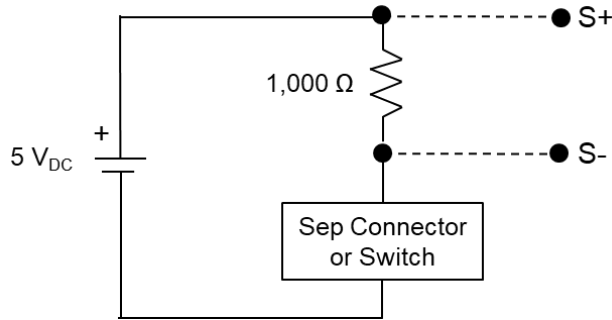

Figure 7-3: Measurement circuit

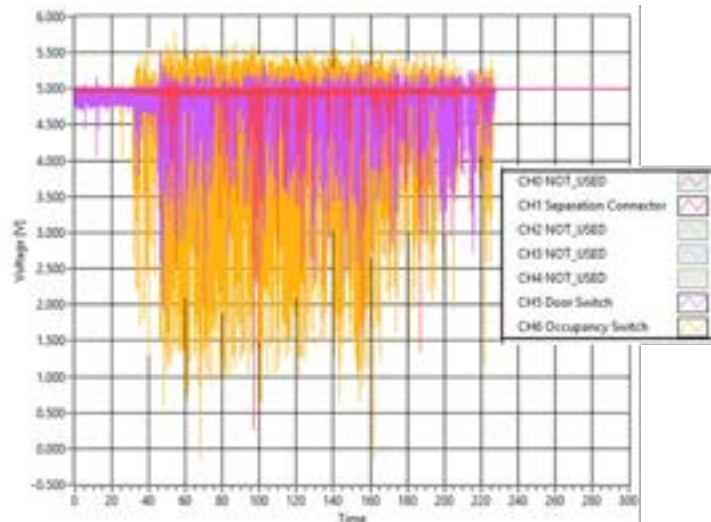

Figure 7-4: Example random vibration intermittency



Figure 7-5: Typical duration of discrete intermittencies

8. INITIATION ELECTRICAL PROFILES

The CSD uses a DC brush motor to release the door. These motors are excellent transducers. For every operation, PSC records the voltage and current profiles from the motor. This enables the health of the mechanism to be safely and inexpensively directly measured in testing and spaceflight. The torque margin is easily calculated to verify it remains above allowables.

PSC also monitors the state of the door and occupancy switches during separation. The ejection velocity of the payload can be approximated using the timing of these two events and assuming constant ejection acceleration from the CSD's constant force spring. See Section 9.

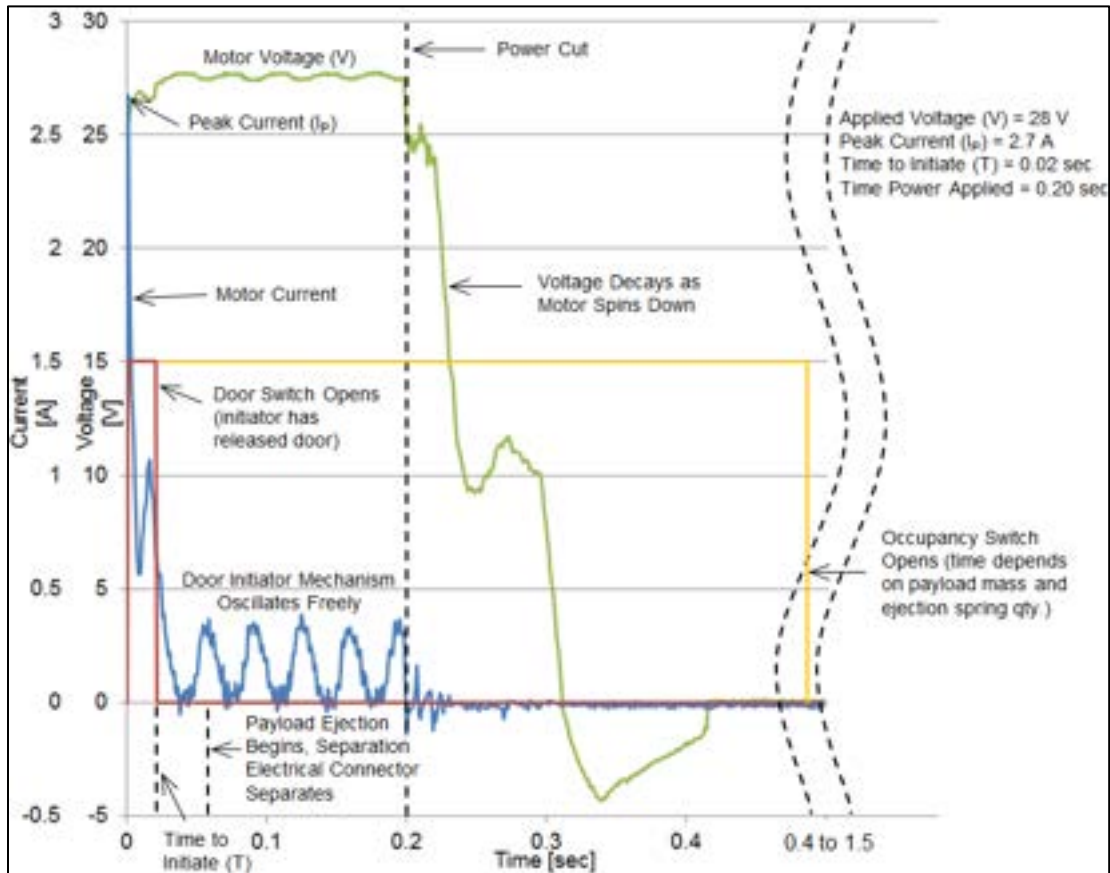

Figure 8-1: Typical initiation electrical profile

Note: The Motor powered duration is 0.2 s in the figure above. PSC typically powers for only 0.1 s during testing to reduce unnecessary cycles on the mechanism.

How to emulate the CSD in electrical system testing: engineers ought to be able to create a circuit that usefully approximates the load of the motor, the state of the switches and separation connector. The motor could be a light bulb of the same resistance, and so on.

9. MAXIMIZE TELEMETRY

It is crucial the launch vehicle (LV) utilizes all CSD switches to maximize flight telemetry and inform anomalies. Both limit switches can be monitored on a single channel by wiring as shown below.

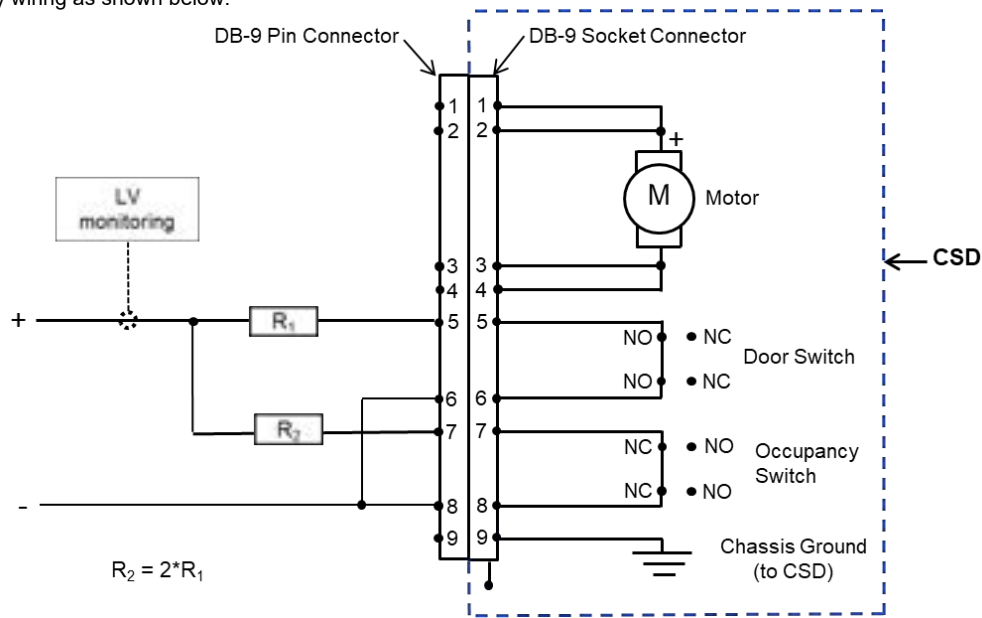

Figure 9-1: Door and Occupancy Switch monitoring

The current flowing through 'LV monitoring' will vary depending on Door Switch and Occupancy Switch state. Thus the state of both switches can be determined from one channel. See Figure 9-2 for example.

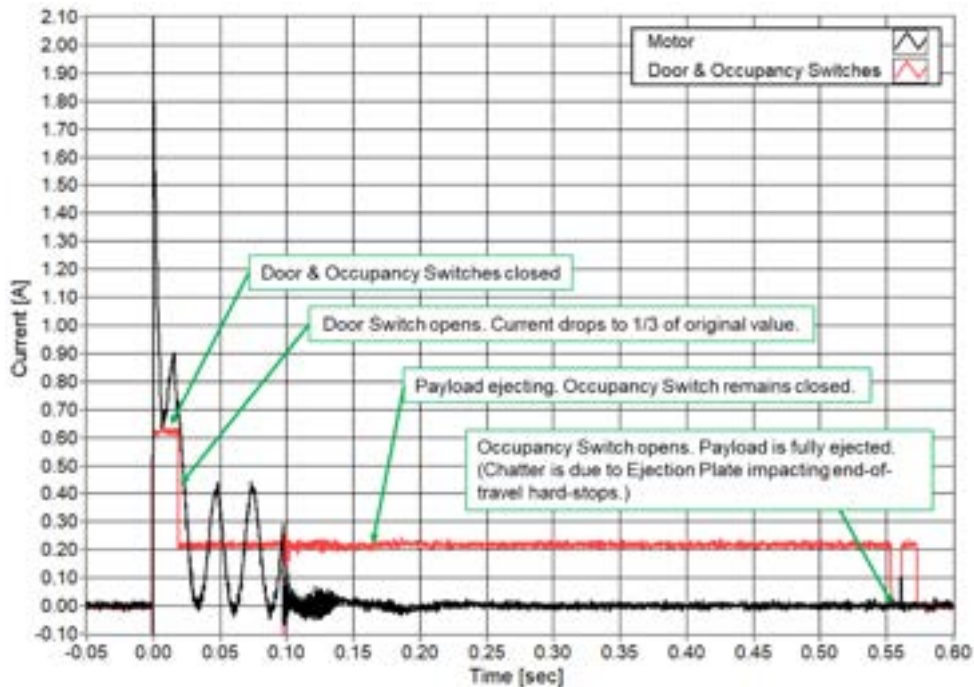

Figure 9-2: Monitoring door and occupancy switch on a single channel

Also, the payload's ejection velocity can be approximated using the timing of the two limit switch activations.

$$V \cong \frac{2 * D}{T_O - T_D}$$

V is ejection velocity [length/time]

D is distance between Ejection Plate's stowed and deployed positions [length] see Figure 15-3

T_O is the Occupancy Switch opening time [time]

T_D is the Door Switch opening time [time]

10. EJECTION PLATE RESISTANCE

The electrical resistance from the CSD's Ejection Plate to the outside of the CSD was measured on 3 different CSDs in a static configuration at room temperature and pressure. A milli-Ohm (kelvin probe) meter was used. The test current and CSD orientation with respect to gravity were varied throughout. Source is PSC document 2003199-. Use the data in Figure 10-1 to Figure 10-3 to roughly approximate the resistance. It will vary greatly for each specific CSD.

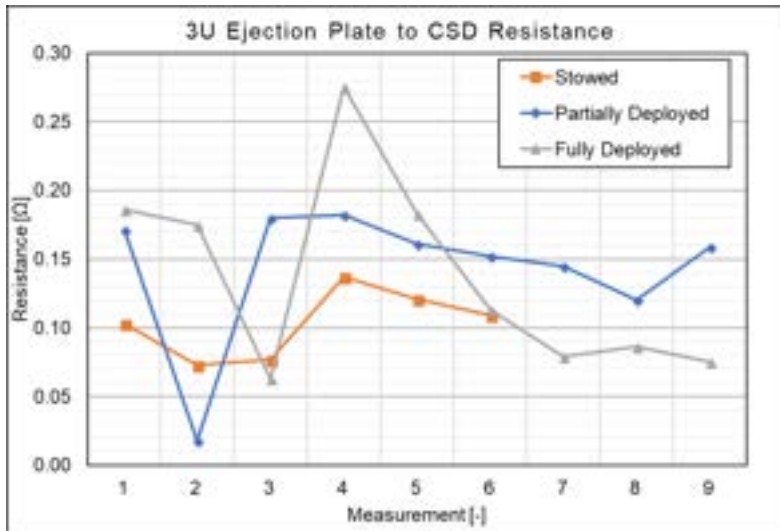

Figure 10-1: 3U Ejection Plate resistance (1 ejection spring)

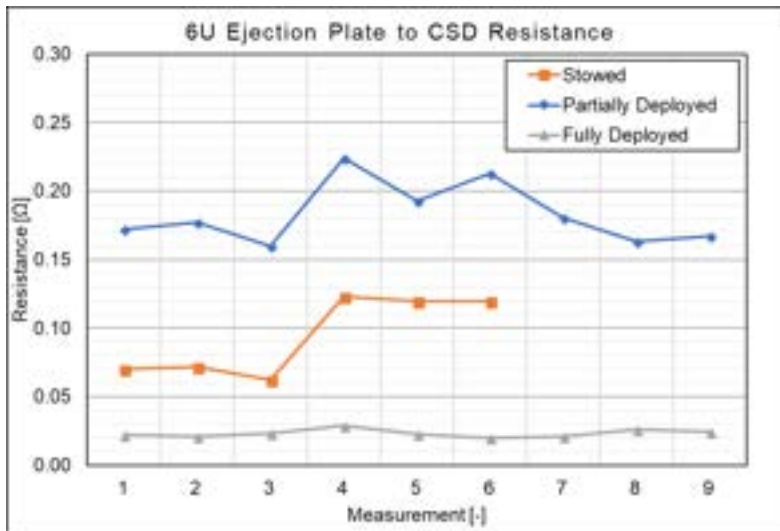

Figure 10-2: 6U Ejection Plate resistance (2 ejection springs)

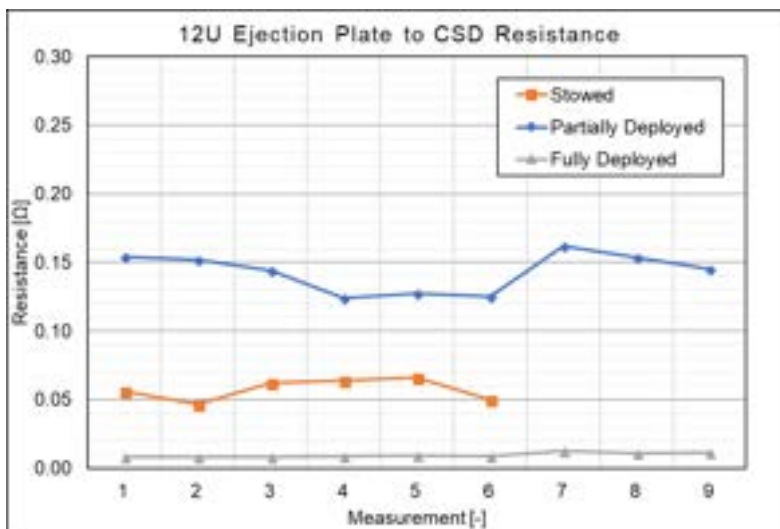

Figure 10-3: 12U Ejection Plate resistance (4 ejection springs)

11. PAYLOAD IN CSD

The figure below shows the size and location of CSD access zones relative to the payload origin. Dimensions apply to all CSD sizes.

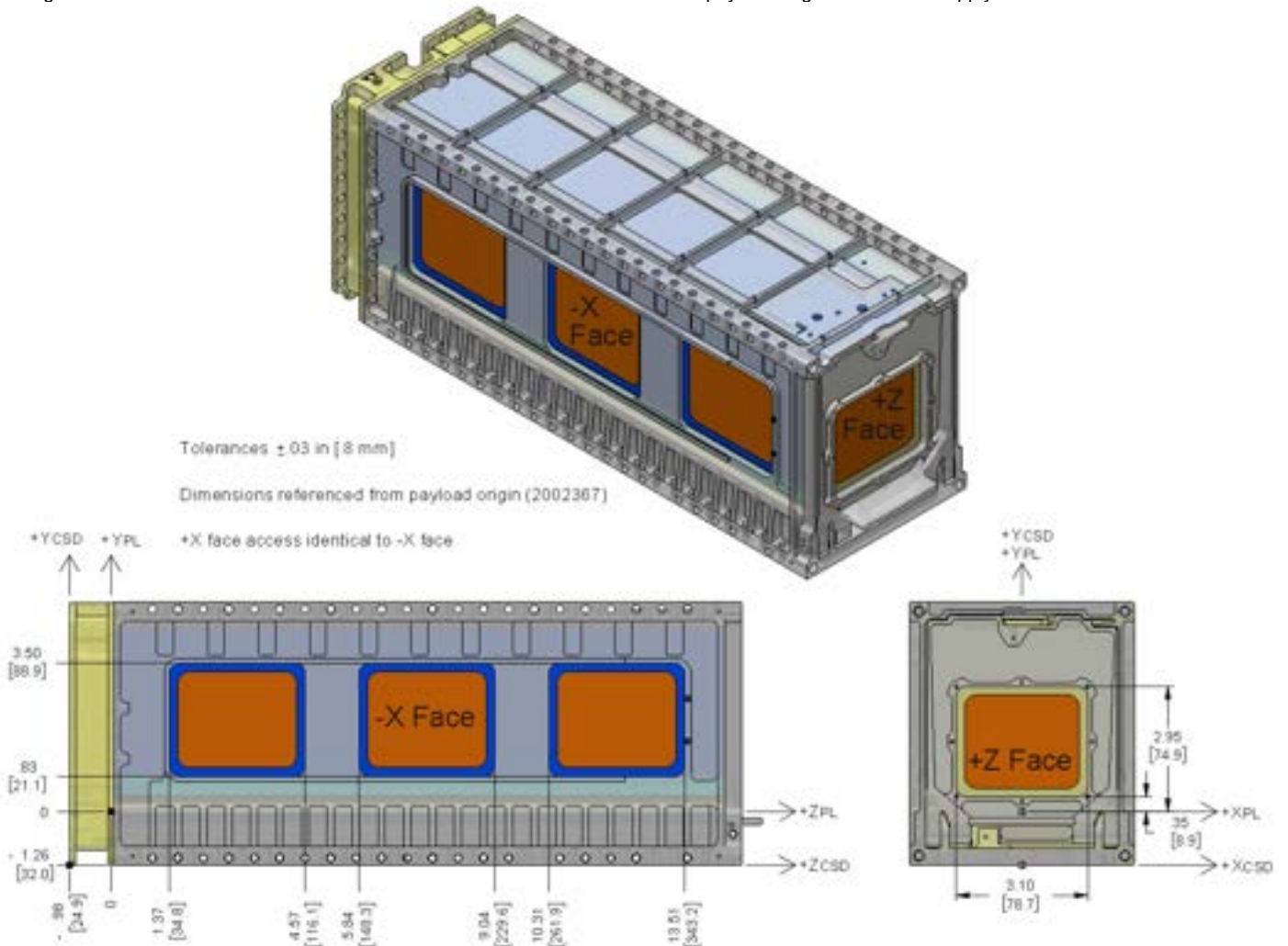

Figure 11-1: Payload location in CSD

Note that a 6U CSD will not accommodate two 3U payloads. Despite the available volume, the CSD will not properly preload the tabs or restrain the payloads. See Figure 11-2.

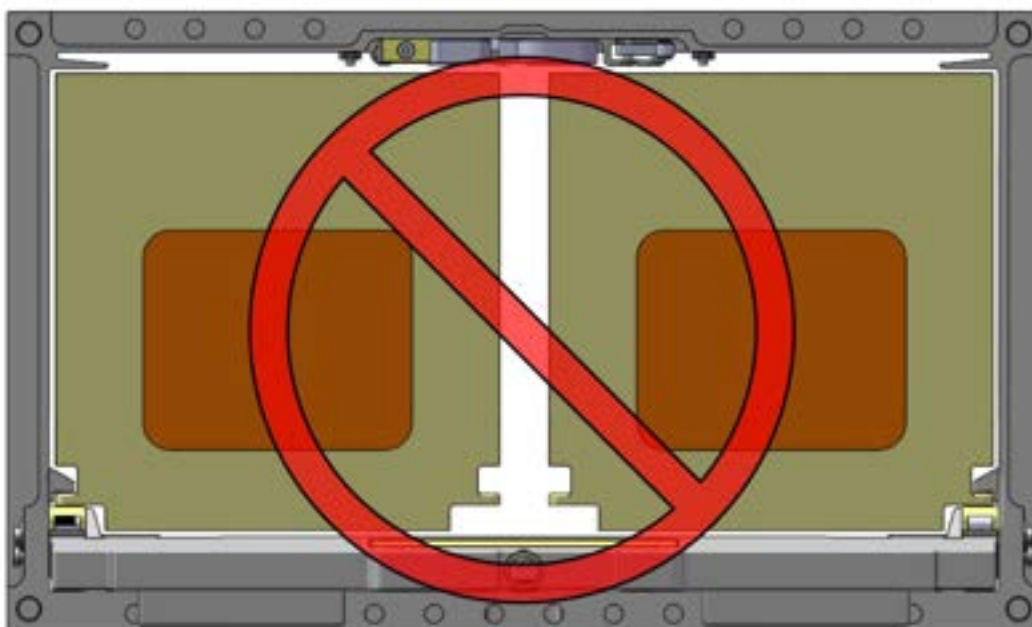

Figure 11-2: Two 3U payloads cannot be installed in a 6U CSD

12. ENVIRONMENTAL TESTING

All flight CSDs undergo environmental tests to verify workmanship. CSDs that have been qualified for a specific mounting face undergo acceptance testing on all flight units. If a specific size and mounting face has not yet been qualified, the flight unit receives proto-flight testing. Mounting the CSD via the -Y or -Z face is considered standard. If planning to mount the CSD via any other face contact PSC for schedule and pricing details. As of the release of this document the following size and mounting face combinations have been qualified.

- 3U: -Y
- 6U -Y & -Z
- 12U: -Y & -Z

PSC records voltage and current during all operations. Flight CSDs perform a minimum 12 separations during testing (EDUs perform 10). 'Separation' is defined as the payload fully ejecting from the CSD. 'Initiation' is defined as the door opening but the payload not fully ejecting, typically due to orientation with respect to gravity. During build every CSD has approximately 5 initiations in addition to the noted separations.

The standard CSD mounting interface is the -Y face for all PSC testing. PSC typically uses 22x (11x per side) high strength .190-32 UNF socket head cap (SHC) screws torqued 50 in·lb for all testing. Example PN is NAS1351N3-12.

12.1 Test Summary

Table 12-1: Test levels

Test	Parameter	Use			EDU
		Qualification	Proto-Flight	Acceptance (Flight)	
Benchtop Separations (1)	Separations [-]	>100	10	10	10
Thermal Vacuum (5)	Temperature [°C] (2)	-34 to +80	-29 to +75	-24 to +61	Not Tested
	Pressure (at separation) [Torr]	<1.0E-4			
	Cycles [-]	≥12	≥8	≥4	
	Separations [-]	≥4 Cold: 22V, 34V Hot: 22V, 34V	2 Cold: 22V Hot: 22V	1 Cold: 22V	
Random Vibration (3,5)	Level [g _{rms}]	14.1 (Figure 12-3 +3dB)		10.0 (Figure 12-3)	Not Tested
	Duration [s/axis]	180	60	60	
	Excitation Axes [-]	X, Y, Z			
	Payload Mass [kg]	3U: ≥6.0 6U: ≥12.0 12U: 9.0 to 24.5	Varies	≤6.5	
Sine Burst (4,5)	Payload Response [lbf]	≥1,000			Not Tested
	Payload Mass [kg]	Varies			
	Cycles, per axis [-]	≥5			
	Excitation Axes [-]	X, Y, Z			
Shock (5)	Level [g]	See Figure 12-5			Not Tested
	Impacts per Axis [-]	3	2		
	Payload Mass [kg]	See Random Vibration			

- (1) 1atm, ~23°C. A separation is also performed after random vibration/sine burst and after shock.
- (2) CSDs have been operated beyond these temperature limits. See Figure 15-2.
- (3) The total dynamic response of the payload is affected by mass distribution, stiffness and damping. Therefore, specifying a maximum allowable payload mass is not productive. During qualification testing the total 3σ payload response often far exceeds 1,000 lbf, especially on the 6U and 12U. To ensure sufficient margin, customers should tune their payload to limit the MPE 3σ response to 800 lbf.
- (4) The peak input acceleration chosen depends on the payload's mass. For instance, with a 9 kg payload installed, at least 50 g is applied to the CSD.
- (5) All qualification levels are inputs to CSD interface, not MPE for launch vehicle.

12.2 Thermal Vacuum

Testing is conducted in PSC's thermal vacuum chamber. The CSD is fastened via the -Y face to aluminum interface plates which are in turn fastened to a copper plate. A heat exchanger pumps refrigerant through tubing on the underside of the plate to conductively heat and cool the CSD.

Location: PSC

Objective: Verify separation at temperature and pressure extremes

Test Description: During this test, the CSD will be thermally cycled in a chamber that maintains vacuum. The payload in the CSD will be separated while still under vacuum at the conclusion of thermal cycling. Upon test completion, the CSD and payload are removed from the chamber and formally inspected.

Test Parameters:

Temperature Range [°C]: -24 to +61 (Values may be exceeded at PSC's discretion).

Thermal Cycles [-]: ≥4

Separation Temperature [-]: hot or cold extreme at PSC's discretion

Pressure at Separation [Torr]: <1E-4

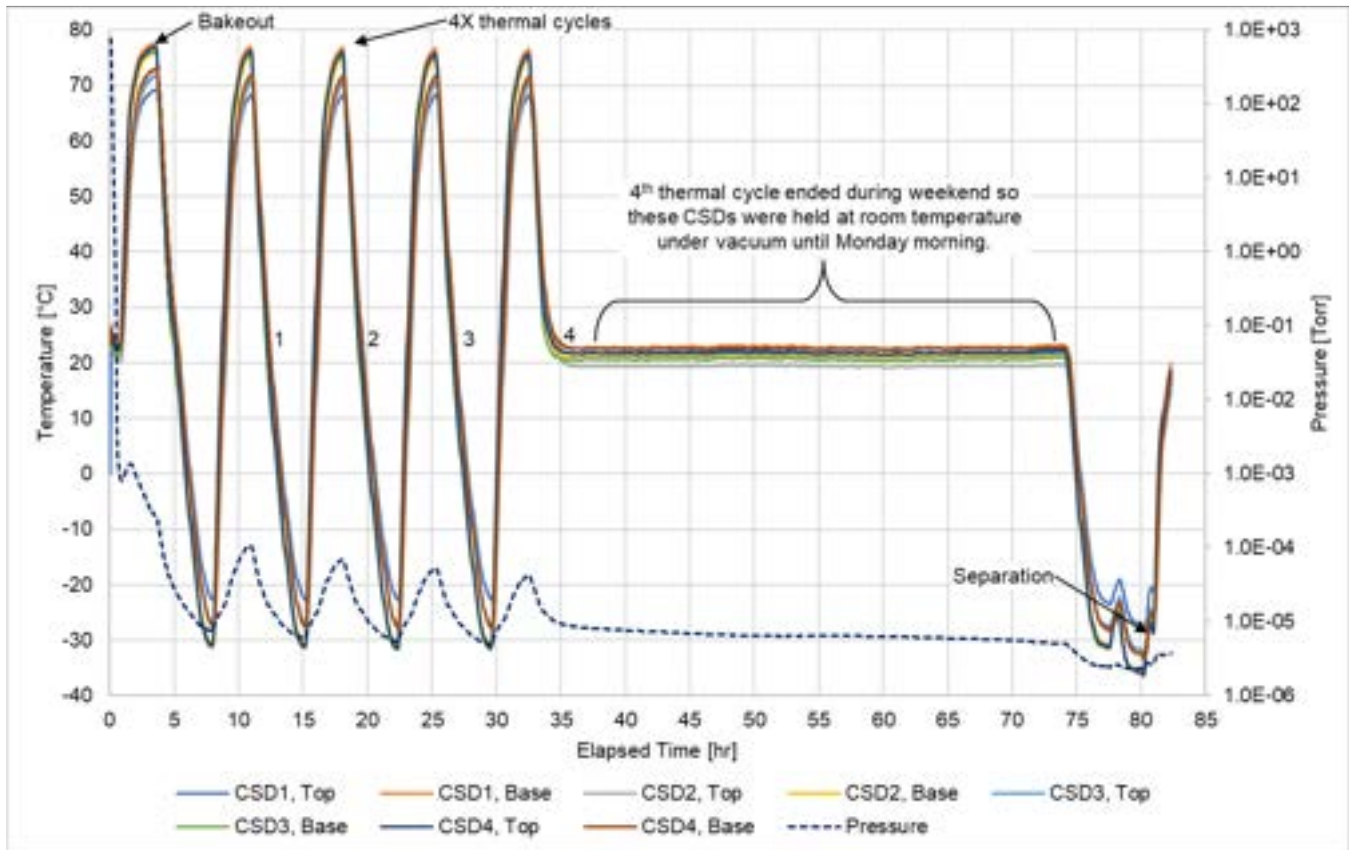

Figure 12-1: Sample thermal vacuum environmental data, 4 CSDs tested concurrently

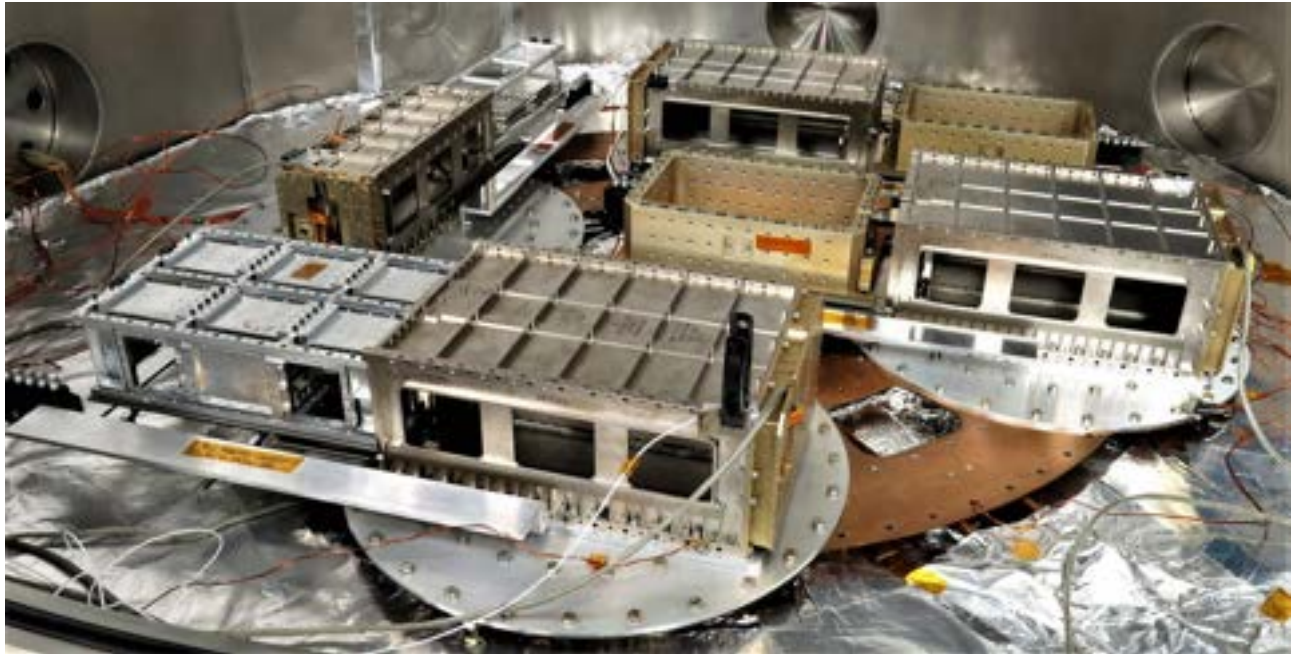

Figure 12-2: Thermal vacuum testing 4 CSDs in PSC's chamber. Conveyors allow complete payload dispensing (see Section 25).

12.3 Random Vibration

- Notes: (1) In a separation the payload completely clears CSD +Z Face. In an initiation the door fully opens but the payload may not eject.
 (2) If additional accelerometers are added, follow the same naming convention wherein C# signifies control and R# signifies response.
 (3) Narrow Bandwidth Exceedance tolerance is the maximum width that a control signal may exceed the control tolerance.
 (4) CSD will have payload installed for all tests.

Test Facility Data Transfer Requirements	
Random: Tabulated data of all levels of ASD profiles and plots of full level ASD profiles.	

Test Orientations	
Axes Tested	X, Y, Z
CSD Mounting Face(s)	-Y

Random Vibration Profile & Tolerances			
Freq. [Hz]	Random Vibration Profile ASD [g^2/Hz]	Upper Ctrl Limit ASD [g^2/Hz]	Lower Ctrl Limit ASD [g^2/Hz]
20	0.013	0.018	0.009
50	0.080	0.113	0.057
800	0.080	0.113	0.057
1,000	0.051	0.073	0.036
1,000	0.051	0.103	0.026
2,000	0.013	0.026	0.007

Pre-Random Vibration Ramp-Up	
Level [dB]	Min Duration [s]
-12	45
-9	45
-6	30
-3	15

Test Flow	
Random Vibration	
Rotate input axis (repeat 2X)	

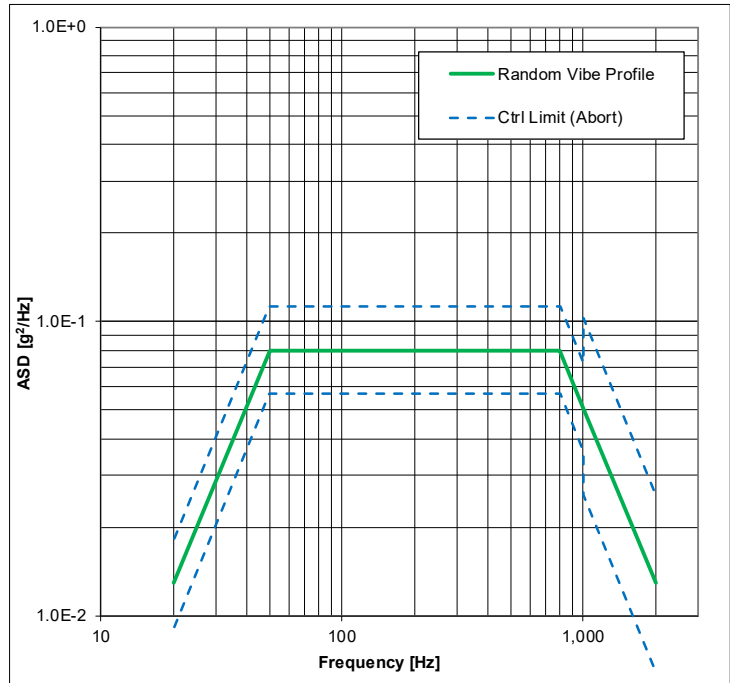

Random Vibration Requirements		
Parameter	Value	Tolerance
Overall [g_{rms}]	10.0	$\pm 1dB$
Duration per axis [s]	61	+5/-1
Ctrl tolerance, 10-1000 Hz [dB]	1.5	-
Ctrl tolerance, >1000 Hz [dB]	3.0	-
Ctrl Strategy [-]	Max	-
Max Ctrl. Bandwidth [Hz]	5	-
NBE Tol, 20-100 [Hz] (3)	10	-
NBE Tol, 100-1,000 [Hz] (3)	10% midband freq.	-
NBE Tol, 1,000-2,000 [Hz] (3)	100	-
Ctrl. Accel Crosstalk Upper Limit [g_{rms}]	In-axis input level	-
Random Vibe DOF per channel [-]	120	± 20
Data Sampling Rate [Hz]	5,000	minimum

Functional Test	
Operation (1)	Commanded
Separation	28.0 \pm 0.5

Payload	
Size [-]	Mass [kg]
3U	2.5 to 6.0
6U	4.0 to 6.5
12U	4.0 to 6.5

Accelerometer Parameters			
Name (2)	Designation	Type	Location
C1	Control	Triaxial	interface plate
C2	Control	Triaxial	interface plate
R1	Response	Triaxial	payload

Figure 12-3: Acceptance random vibration test requirements

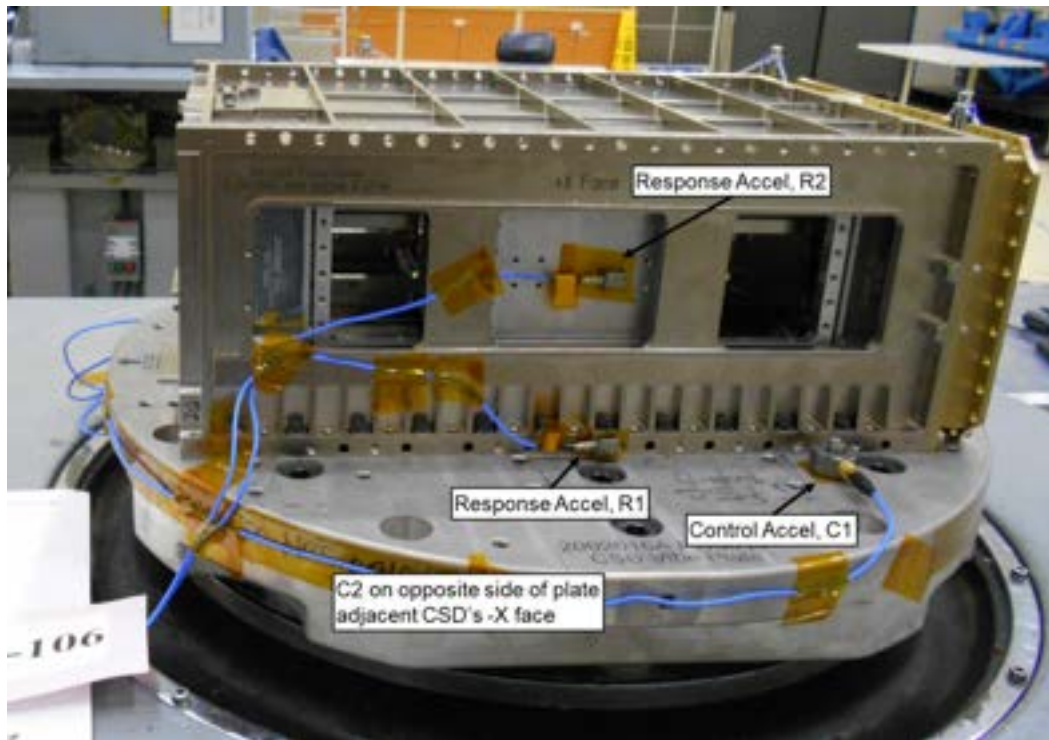
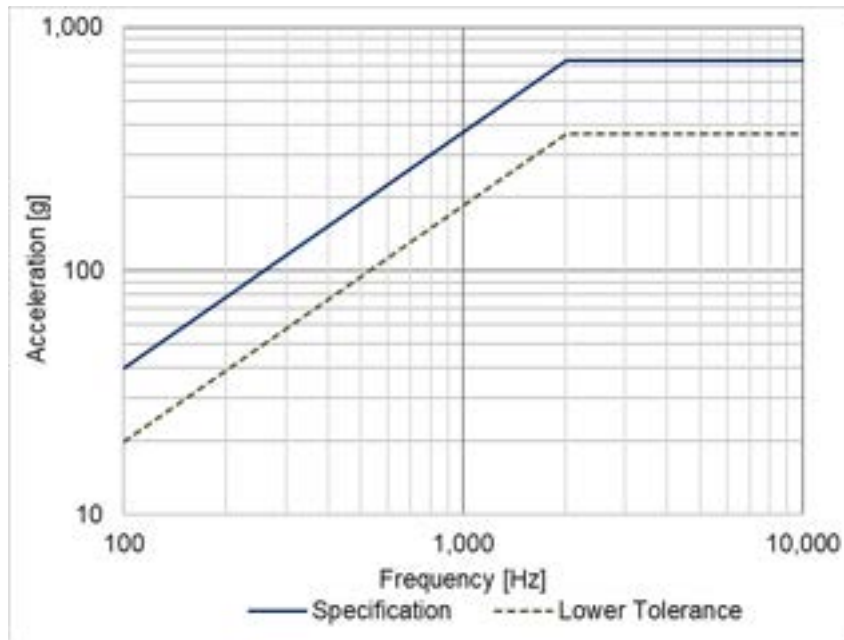

Figure 12-4: Typical 6U CSD vibration test setup

12.4 Applied Shock (not a standard test)

Shock testing is only performed on qualification and proto-flight units. Figure 12-5 shows the qualification applied shock SRS specification for the CSD. For each impact and axis >50% of the curve is above the specification. Both the positive and negative SRSs meet the tolerance. This is measured at the CSD interface surface, <2 in from the CSD. Figure 12-6 shows a representative time domain impact. Figure 12-7 shows a representative test setup.



Frequency [Hz]	Lower Tolerance [g]	Specification [g]	Slope [dB/Oct]
100	20	40	5.82
2,016	365	730	
10,000	365	730	0

Figure 12-5: CSD applied shock specification

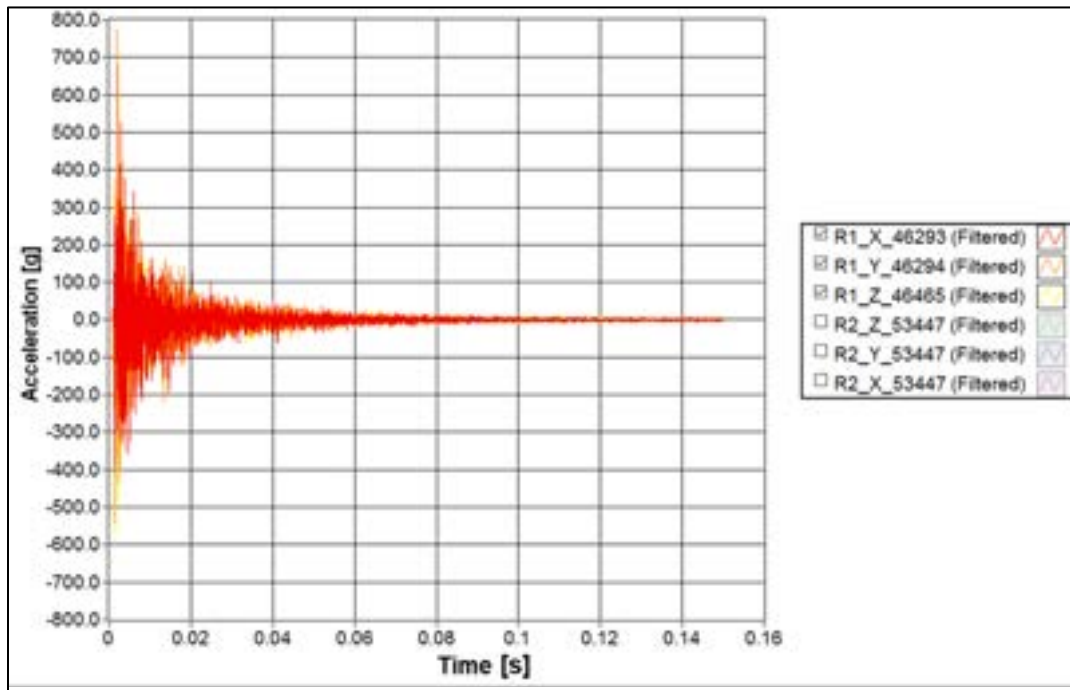

Figure 12-6: Representative time domain shock impact

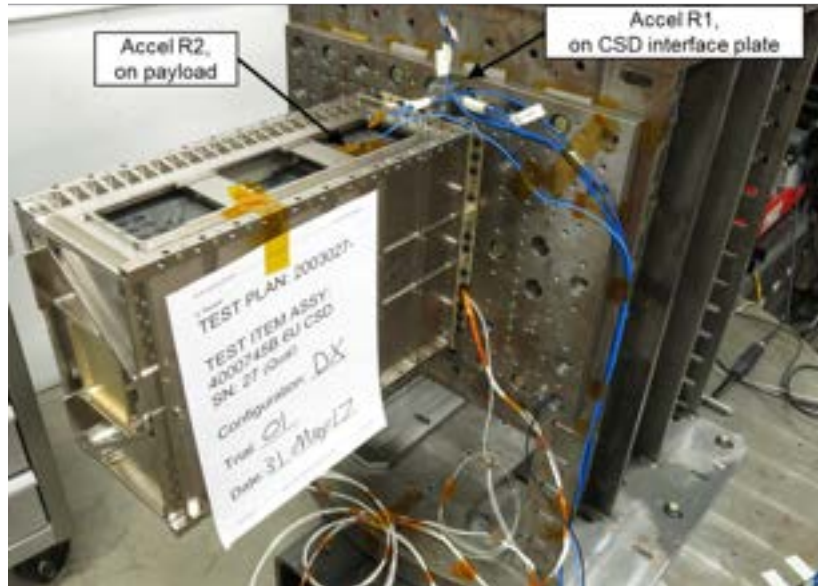

Figure 12-7: Qualification applied shock test setup, 6U, -Z mtg face

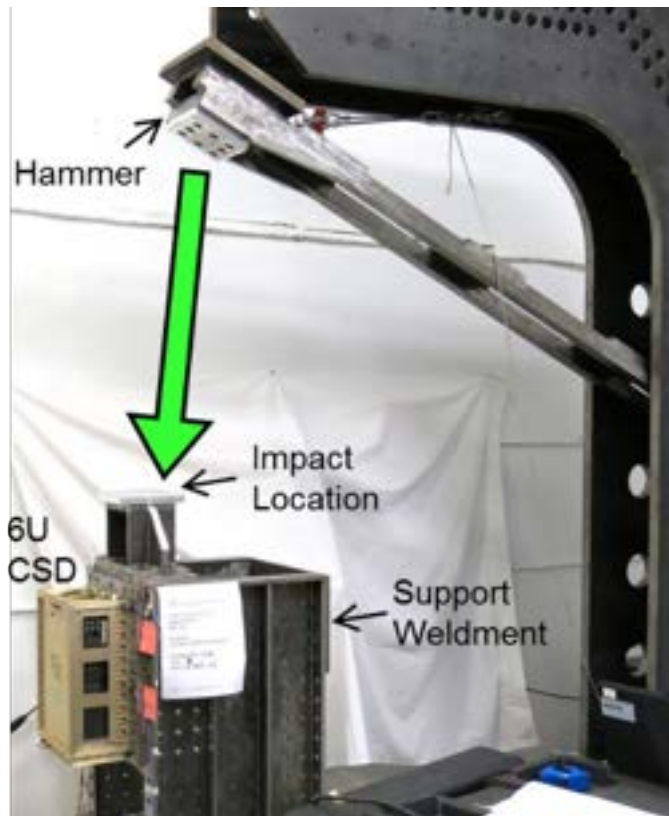

Figure 12-8: PSC's shock test fixture

13. CSD-GENERATED SHOCK

Figure 13-2 represents the shock generated by the CSD as a result of opening the door and dispensing the payload. 13 separations were performed on a 12U CSD and the SRS shown are the Normal Tolerance Limits (NTL) with a P95/50 confidence. They envelope all trials. The locations of the accelerometers were varied along the length to encompass spatial variations. See Figure 13-1. Maximum thickness (.1200 to .1206 in) payload tabs were used that envelope the allowable thickness since the clamping preload, and thus strain energy, varies with tab thickness. Figure 13-4 shows an example time domain of a single separation. The multiple impacts are from the CSD's door bouncing. Only the initial impact was analyzed for Figure 13-2 since creating an SRS of the entire event produced noise at lower frequencies. This data is from a 12U CSD. The 3U and 6U have different door inertias but it is assumed they behave similarly as the strain energy released during initiation is nearly identical for all sizes. Also, this testing was performed with gravity acting in the -Y direction, thus adding energy to the door's release.

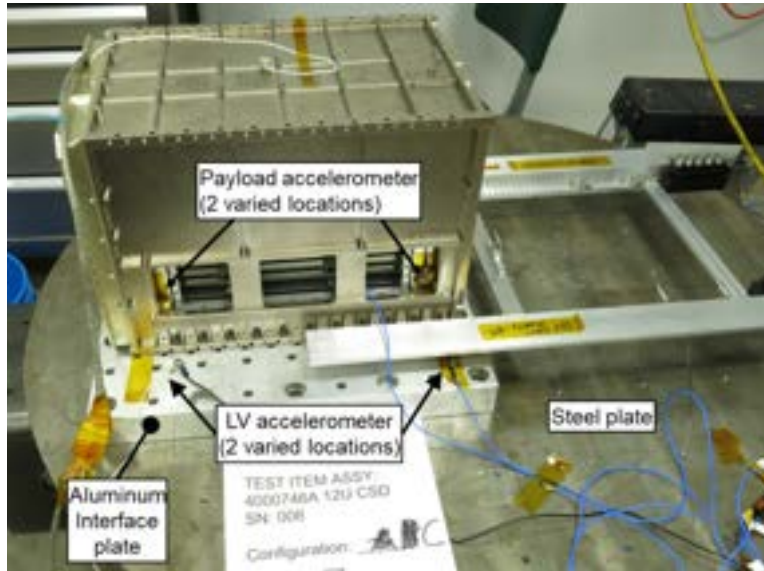

Figure 13-1: Test setup to measure CSD generated shock

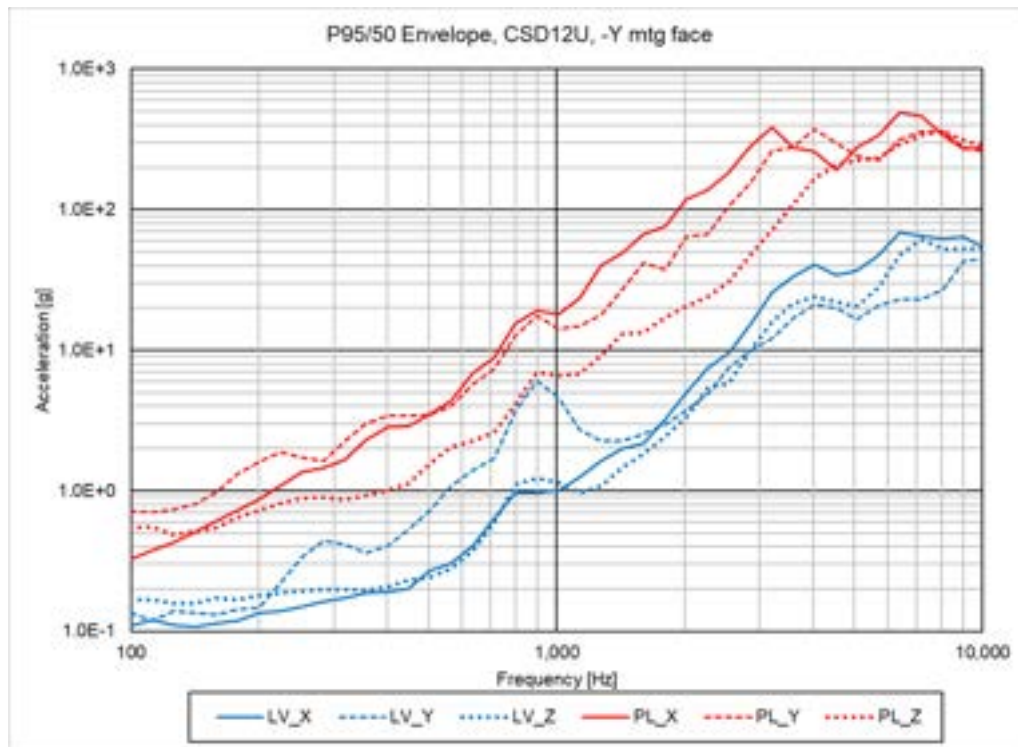

Figure 13-2: CSD generated shock SRS

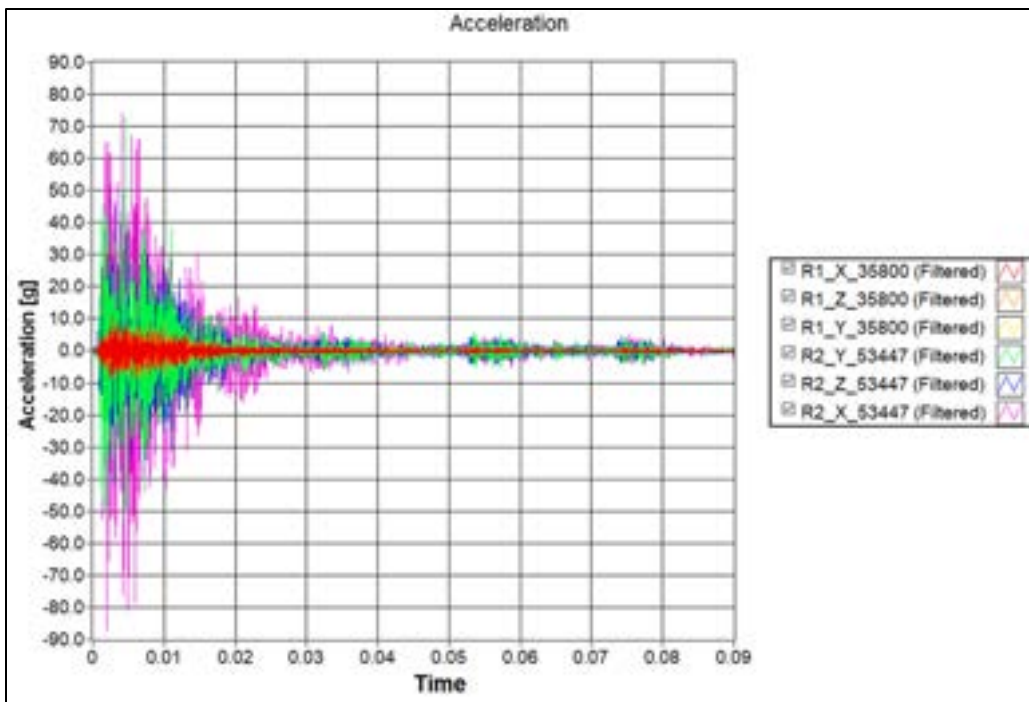

Figure 13-3: Representative time domain CSD generated shock, initial impact (R1 LV, R2 payload)

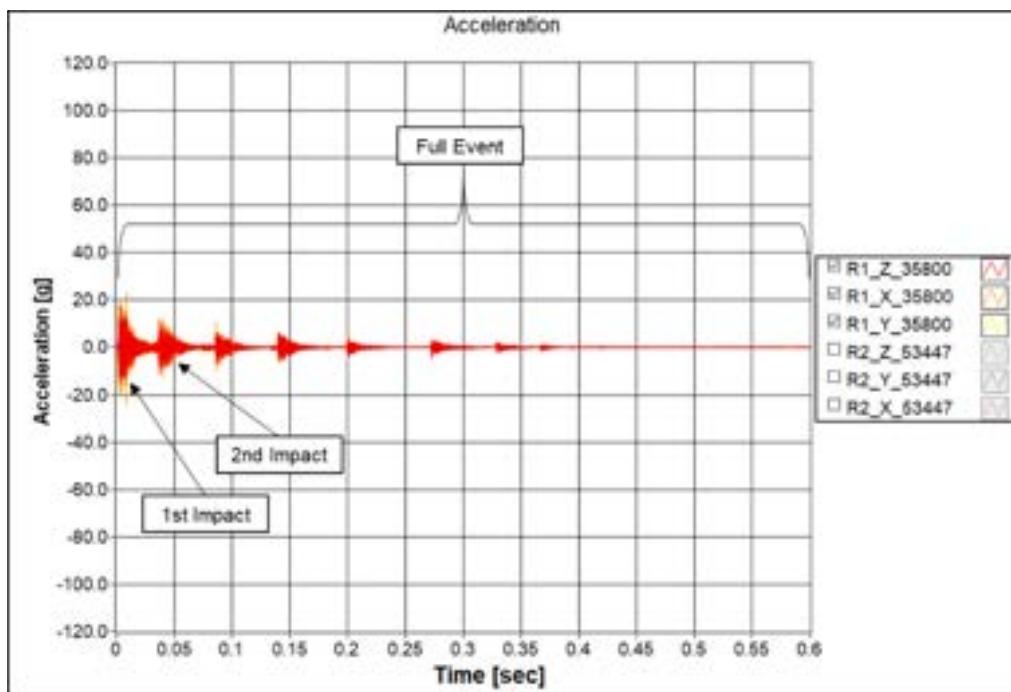

Figure 13-4: Representative time domain CSD generated shock, full event

14. MICRO-GRAVITY FLIGHT

In August 2014, PSC conducted micro-gravity flight testing of the 3U and 6U CSDs aboard NASA's Weightless Wonder aircraft. The testing took place over 4 flights with about 40 parabolas per flight. The 3U CSD was operated 52 times in micro-gravity and the 6U CSD was operated 84 times in microgravity. The separation velocity and tip-off rates of the payload were measured during each operation. Videos and papers of CSD operations during the micro-gravity testing can be found at www.planetarysys.com. These papers explain the scatter in the rotation and velocity measurement which are expected to be lower on orbit (ref. 11).

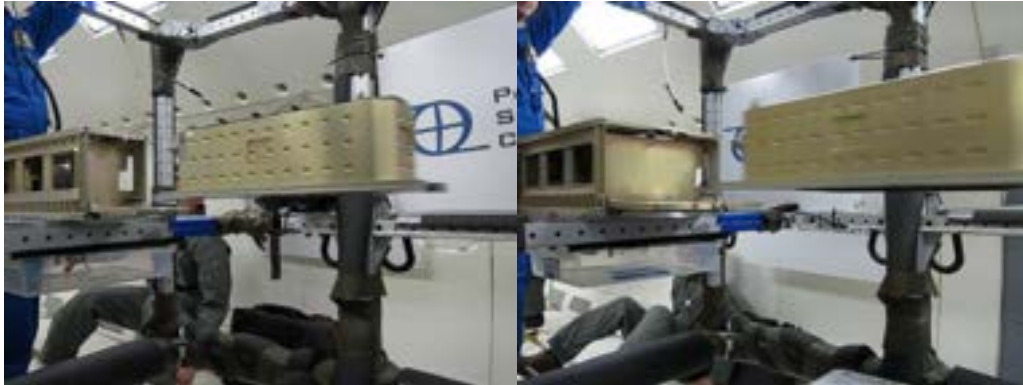

Figure 14-1: 3U and 6U deployment in micro-gravity

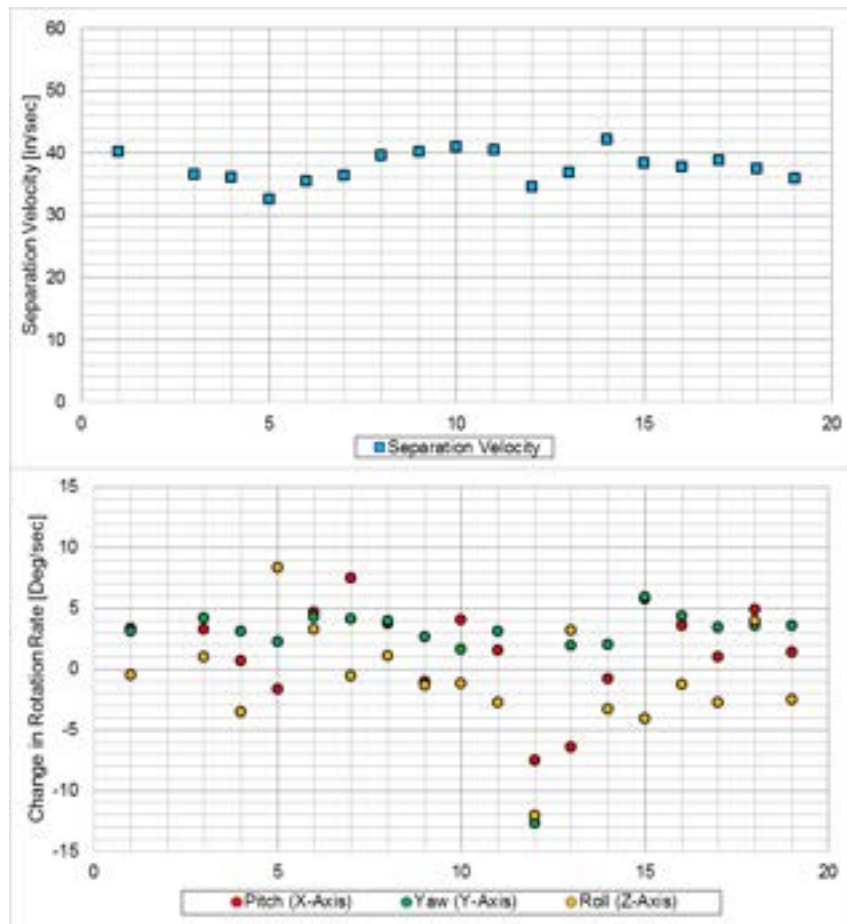

Figure 14-2: Flight 3, 3U CSD (1 spring, 9.94 lbm payload)

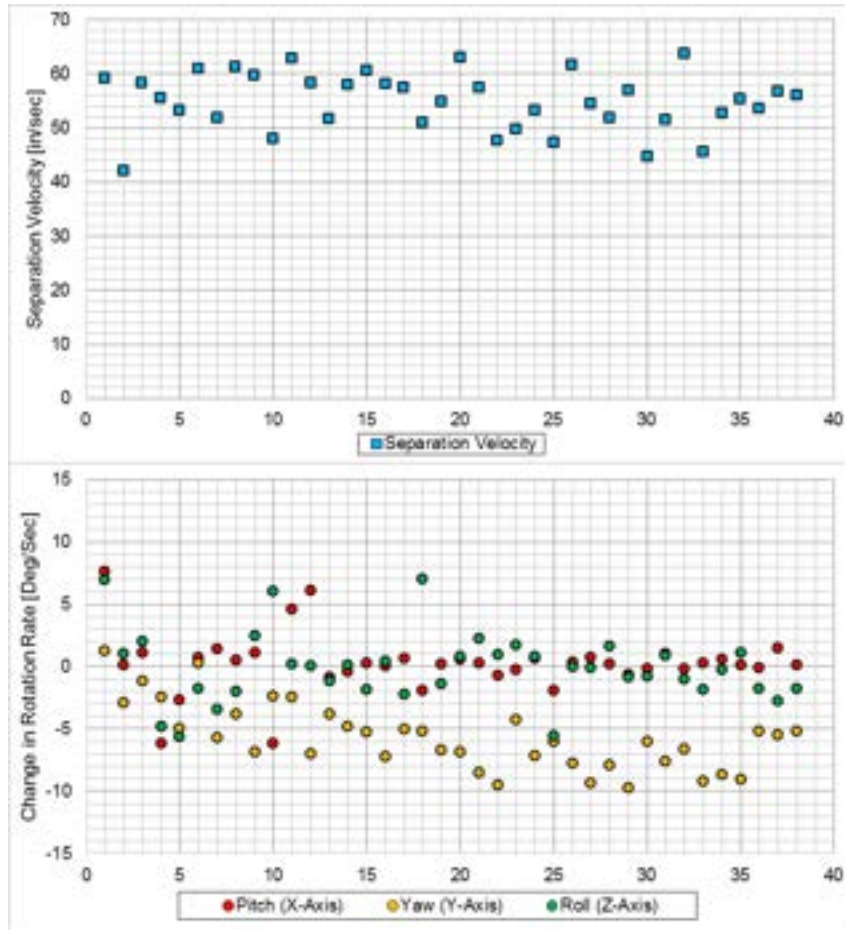

Figure 14-3: Flight 4, 6U CSD (4 springs, 19.85 lbm payload)



Figure 14-4: Test structure floating during micro-gravity test

15. PAYLOAD EJECTION

The CSD can be configured with multiple ejection springs: one or two for the 3U, two or four for the 6U/12U. See Section 26 for defaults. The graph below provides estimated payload ejection velocities using data averaged from micro-gravity flight testing of the 6U and 3U CSD. It is assumed that the 6U and 12U CSD behave similarly. These apply at room temperature. See Section 14 for typical scatter on these nominal values.

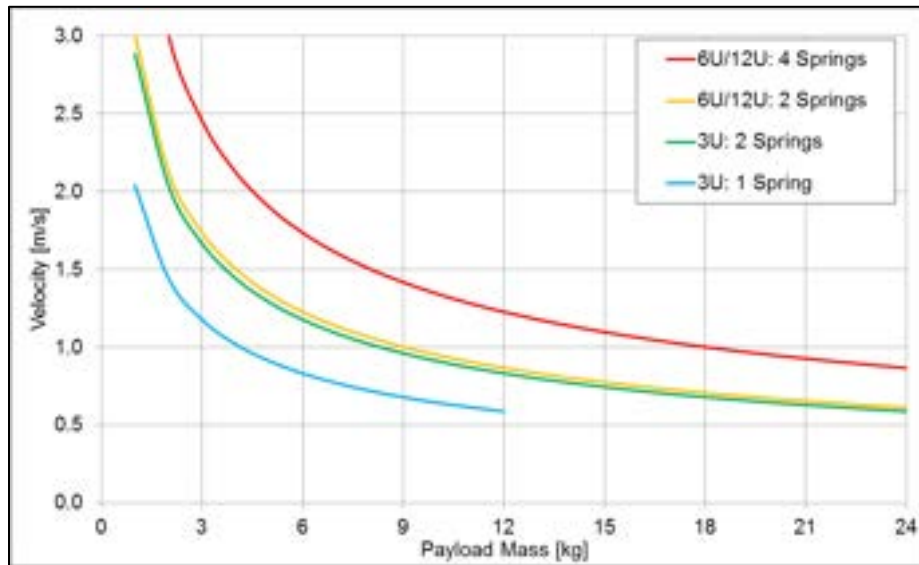

Figure 15-1: Estimated payload ejection velocity

Figure 15-2 shows the effect of temperature on ejection velocity. ‘Separation Time’ is defined as the duration between the door switch opening and the occupancy switch initially opening (Ejection Plate reached end of travel, CSD deployed). This corresponds to approximately 13.3 in of payload travel. See Figure 15-3 for exact Ejection Plate distances. Separation time is proportional to velocity. The masses listed are the payload mass. All operations were performed in a thermal vacuum chamber, Pressure < 1.0E-4 Torr and CSDs oriented with gravity in -Y direction. Notice the 3U speed dramatically slows below -40 °C. This is believed due to viscosity of the lubricant in the Ejection Plate’s linear bearing.

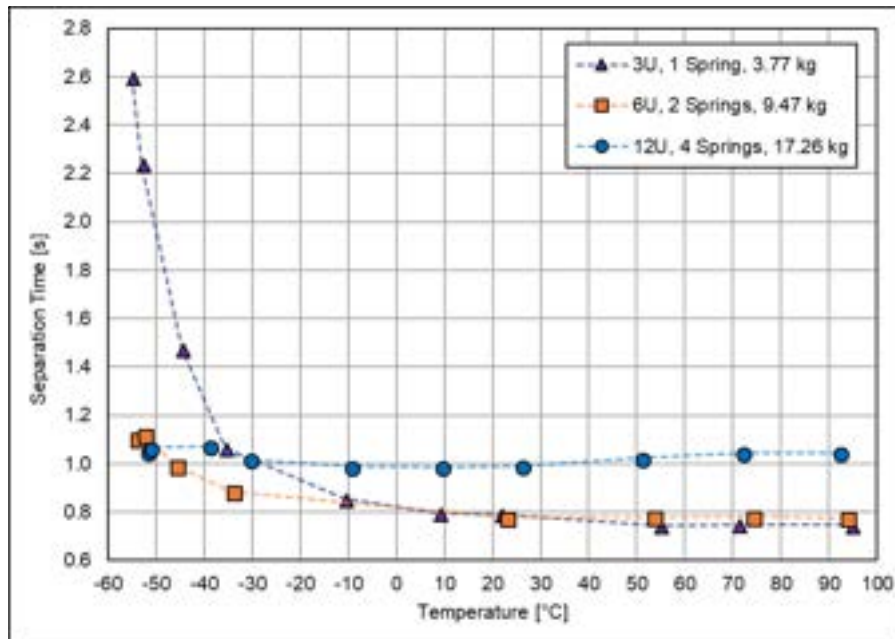

Figure 15-2: Ejection time vs. temperature

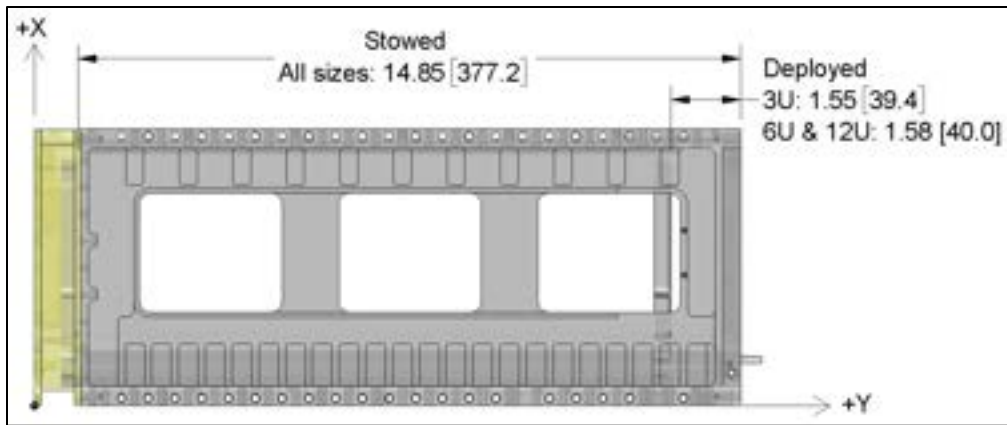

Figure 15-3: Ejection Plate travel

Figure 15-4 shows the Separation Time for the 6U qualification benchtop test. Operations 1, 81 & 91 were the initial use of new payload tabs. Notice the 'work-in' period associated. The specific reasoning is unknown but likely related to slight polishing of surface imperfections and thus a reduction in friction. Also note that operations 81 to 120 were with payload tabs outside of the allowable thickness tolerance per *Payload Specification 2002367*. PSC tests with tabs that envelope the allowable tolerance to ensure reliability. Source is PSC document 2003030.

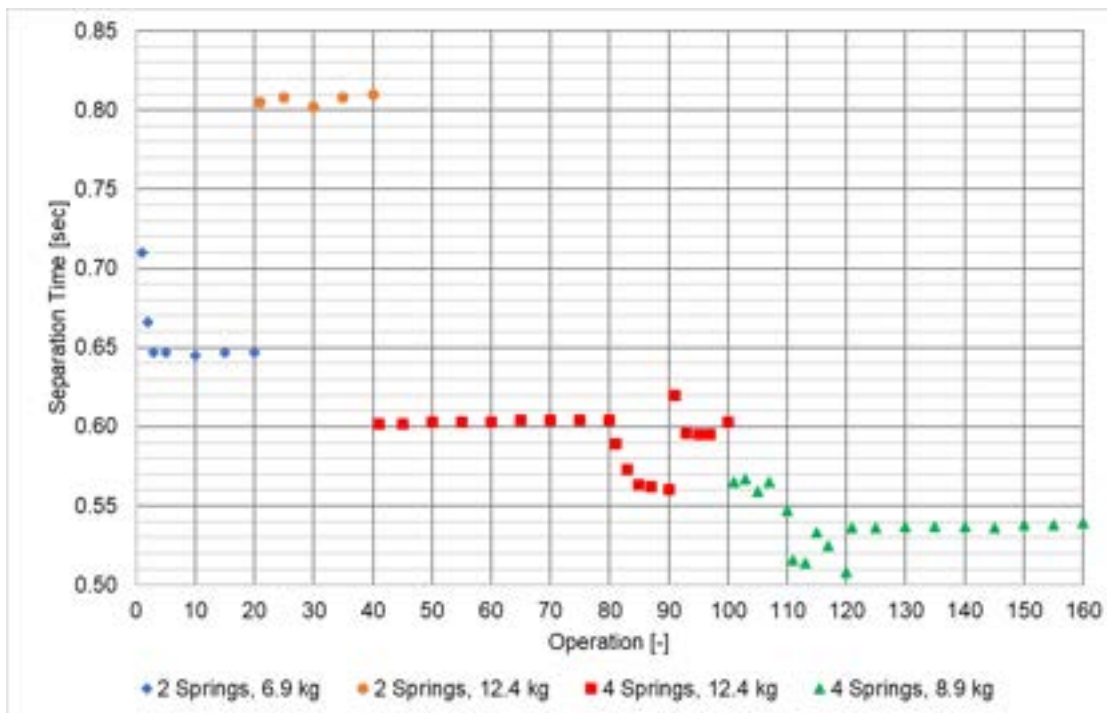

Figure 15-4: 6U qualification benchtop separation summary

16. DOOR BOUNCE

During ejection the CSD's door will bounce and contact the leading edge of the payload (-Y, +Z edge). To prevent payload damage avoid placing sensitive components on the -Y face near the +Z leading edge of the payload. Utilize a structural protrusion or bumper to help protect sensitive components. Small Delrin plastic bumpers have proven successful on test payloads.



Figure 16-1: Door bounce

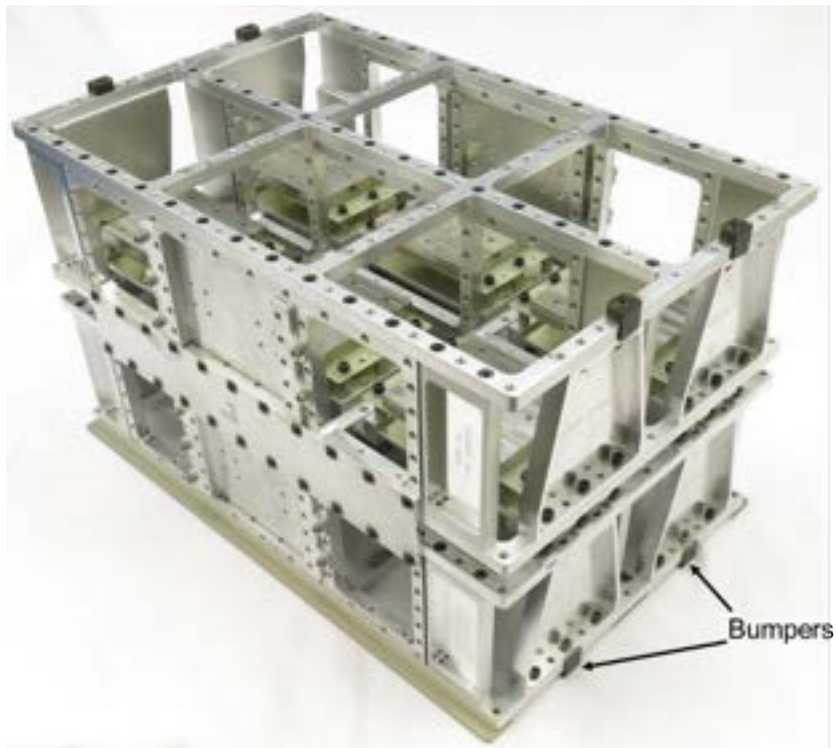

Figure 16-2: Payload bumpers

Figure 16-3 shows example door angle vs. time during payload ejection. $T = 0$ s corresponds to power on to the CSD initiator (motor). Impact frequency and decay rate are dependent on both payload mass and ejection spring quantity, both of which are unknown for the data presented. Source is PSC document 2003130. See Table 4-1 for the door's mass moment of inertia.

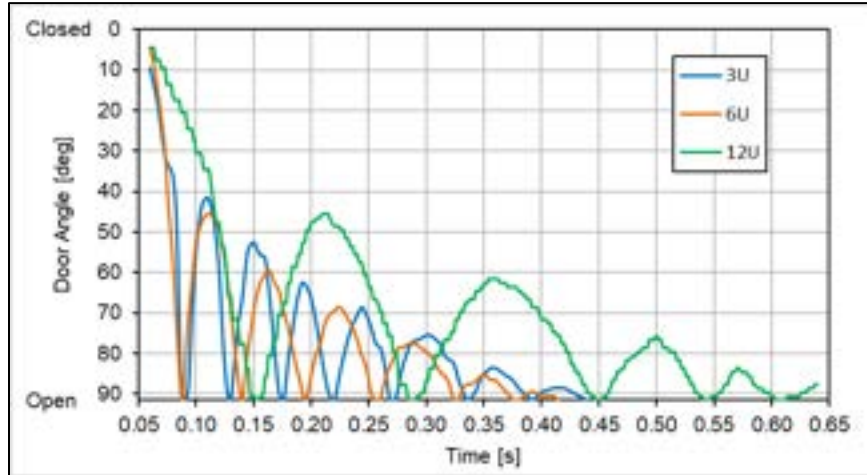

Figure 16-3: Example door bounce during ejection

The torque on the CSD's door during both opening and closing was measured for all three sizes. It was first measured with a payload installed and then repeated without a payload. See Figure 16-4 and Figure 16-5. The hysteresis is due to friction. With the payload installed, all three sizes are very similar because the majority of the torque results from the tab preload system which is identical for all CSDs. Without the payload, the 3U experiences less torque because it has fewer internal springs than the 6U and 12U. The CSD was oriented with gravity in +X to minimize gravity induced torques. See Figure 16-6. Source is PSC document 2003108.

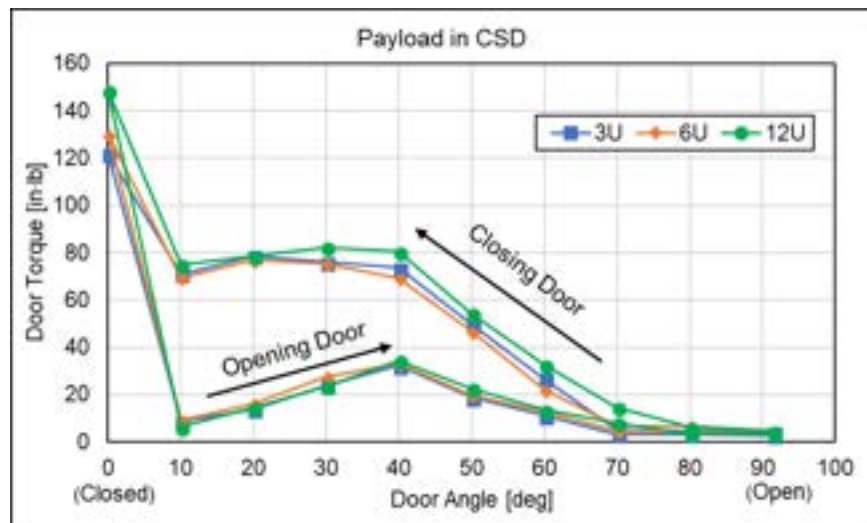

Figure 16-4: CSD door torque with payload installed

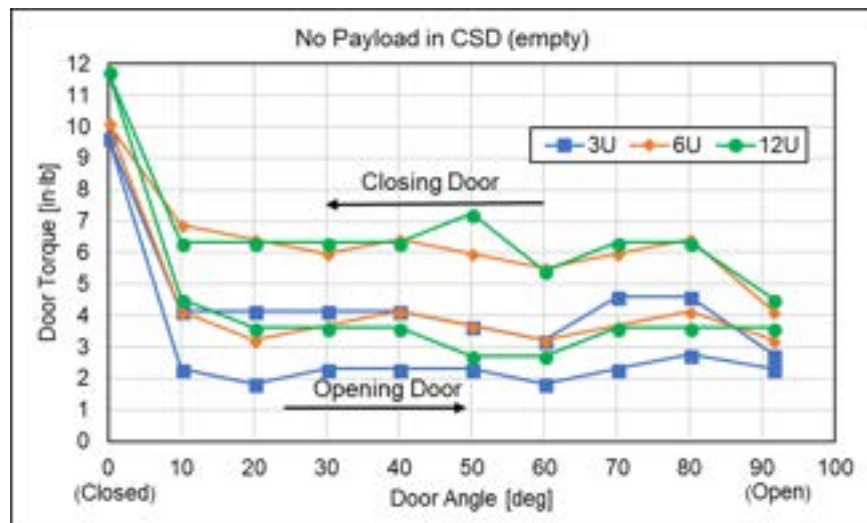

Figure 16-5: CSD door torque without payload (empty)

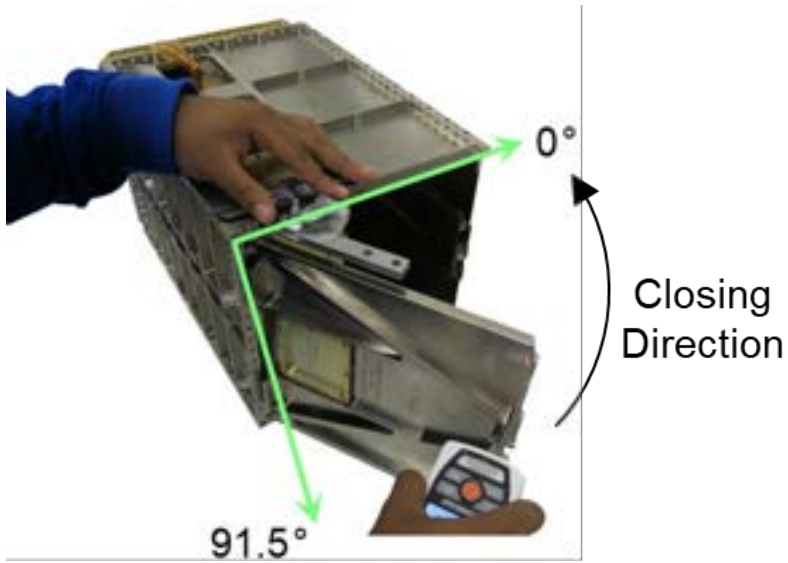

Figure 16-6: Door torque test setup

17. ALLOWABLE PAYLOAD RESPONSE

The 3σ RSS payload response due to all loading shall not exceed a total of 800 lbf (3,560 N) on both tabs. This capability is verified with margin on qualification and proto-flight CSDs.

Simply claiming a dispenser can accommodate a certain payload mass is not productive because every payload has a unique dynamic response. The loading on the CSD is affected by the variable stiffness, damping, and effective mass of each payload. Figure 17-1 illustrates the extreme difference in response of two payloads of the same mass. Higher damping within the payload and/or isolation between the CSD and launch vehicle greatly increases the mass capability.

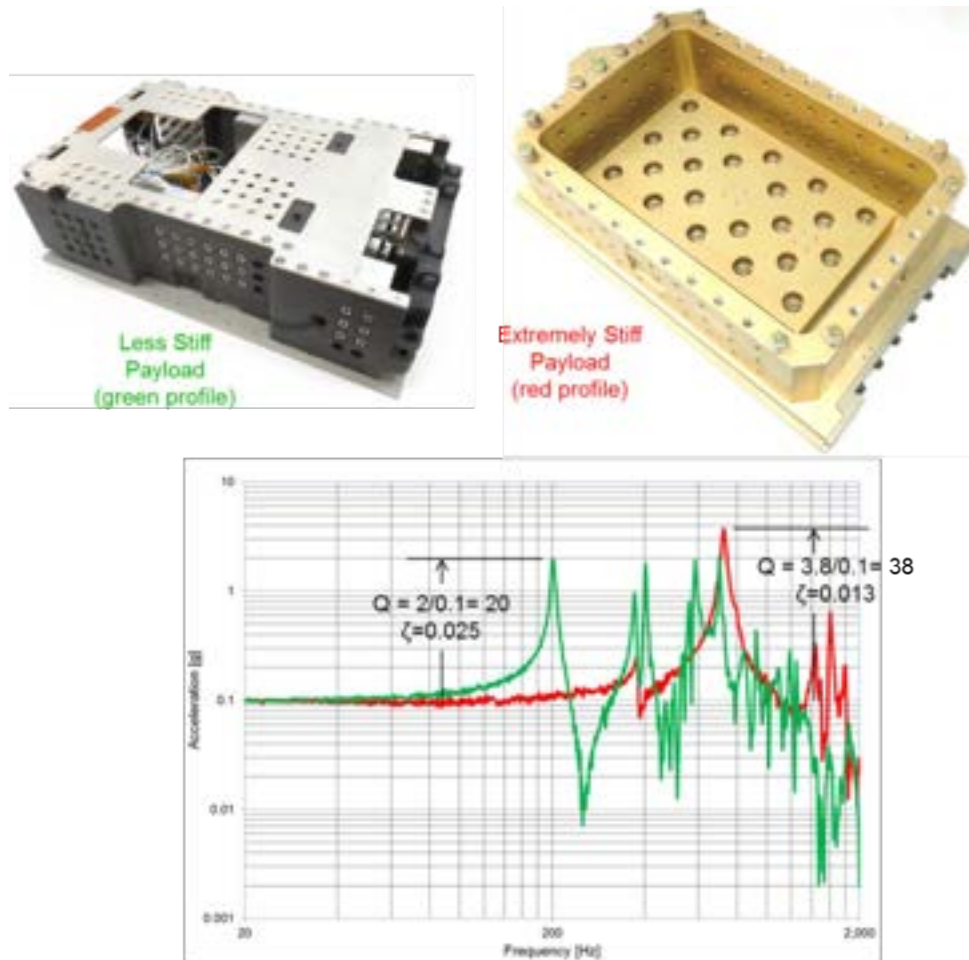

Figure 17-1: Payload response comparison

As a further example a 12 kg 6U payload exhibited a lower total response than a 9 kg payload despite being 33% heavier. Both were tested in the same CSD with the same $14.1 g_{rms}$ input.

It is important to note that the total 800 lbf response limit does not typically result from the quasi-static launch acceleration multiplied by payload mass. For example if the launch vehicle provides an 8g launch load, the payload cannot be 100 lb. Resonances and low damping can create higher effective responses than 8 g. Isolation systems can increase damping and move the resonant frequency. This is what larger vehicles do: coupled loads analysis, then if the response is too high, isolate or strengthen. If encapsulation is not absolutely necessary use a Lightband instead. It is lighter, supports much larger loads, allows larger volumes and has lower tip-off.

Contact PSC if the 800 lbf response requirement is problematic. The capability can possibly be increased (~10%) on a case-by-case basis. PSC developed this conservative limit to ensure the payload never detrimentally slips.

To verify reliability, PSC has purposely exceeded these forces during shock testing. The payload slipped until it pushed against the door and then a complete separation was performed. This however is not recommended as it could introduce several failure modes, especially during vibration, including: FOD generation, load path change, activation of inhibits, damage to deployables, etc.

18. TAB GAPS & DISCONTINUITIES

The CSD can accommodate payloads with tab gaps greater than those listed in the Payload Specification 2002367 (ref. 3). **However this may result in a customized CSD and increase cost and/or delivery time.** If the payload will have gaps that do not comply with the Payload Specification contact PSC to discuss requirements and obtain a custom quotation.

The allowable payload response will decrease approximately as a percentage of the tab length removed. Carefully consider this when electing to have gaps. Further, PSC's test payloads do not have tab gaps. It is highly recommended that the customer tests a mockup of the payload in an EDU CSD to verify performance.

Also consider the impact of large gaps on the ability to verify full separation of the payload from the CSD during test. Large gaps will increase design complexity of a conveyor system as there is no longer a continuous tab surface for the payload to roll on.

Locating the gap(s) in the middle of the payload is preferred. Maintaining continuous tabs at the fore and aft ends maximizes the load capability of the CSD and aides installation/removal.

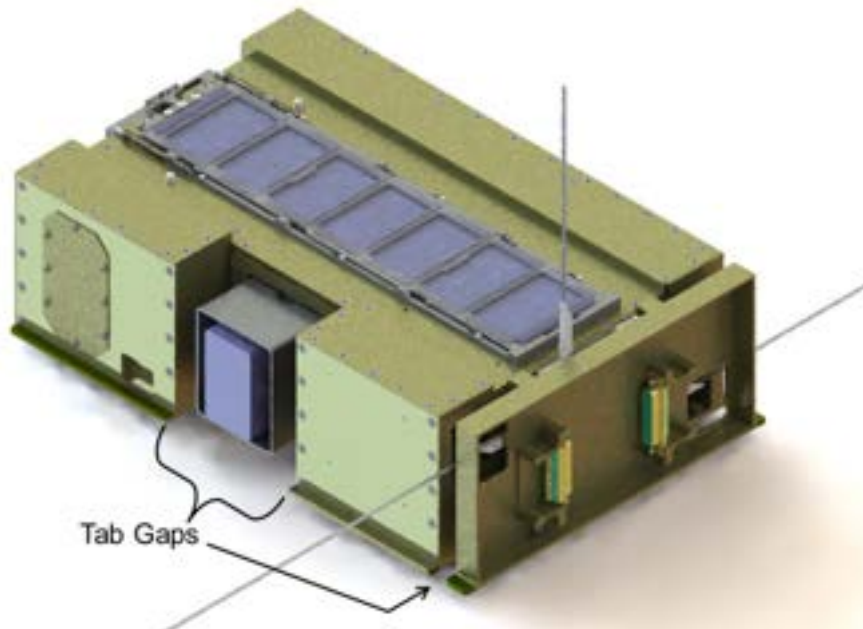

Figure 18-1: Payload with large tab gaps requiring a custom CSD

19. PAYLOAD VOLUME

The CSDs external volume is equivalent or smaller than other dispensers while simultaneously allowing the largest payload volume.

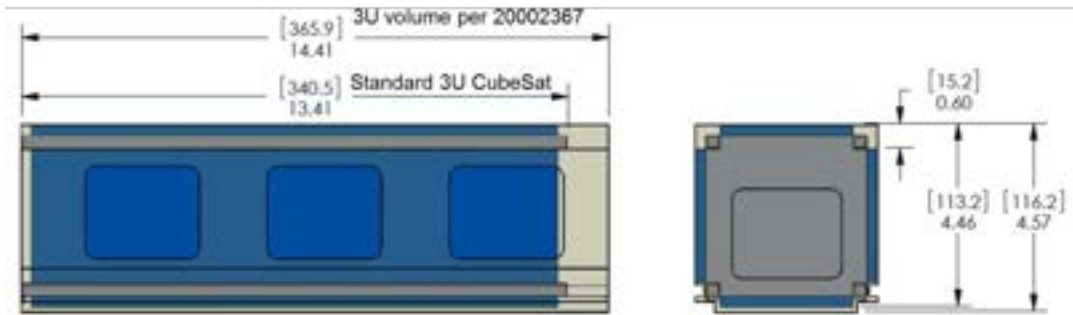

Figure 19-1: Comparison of 3U Payload Volumes. The CSD allows 15% more payload volume.

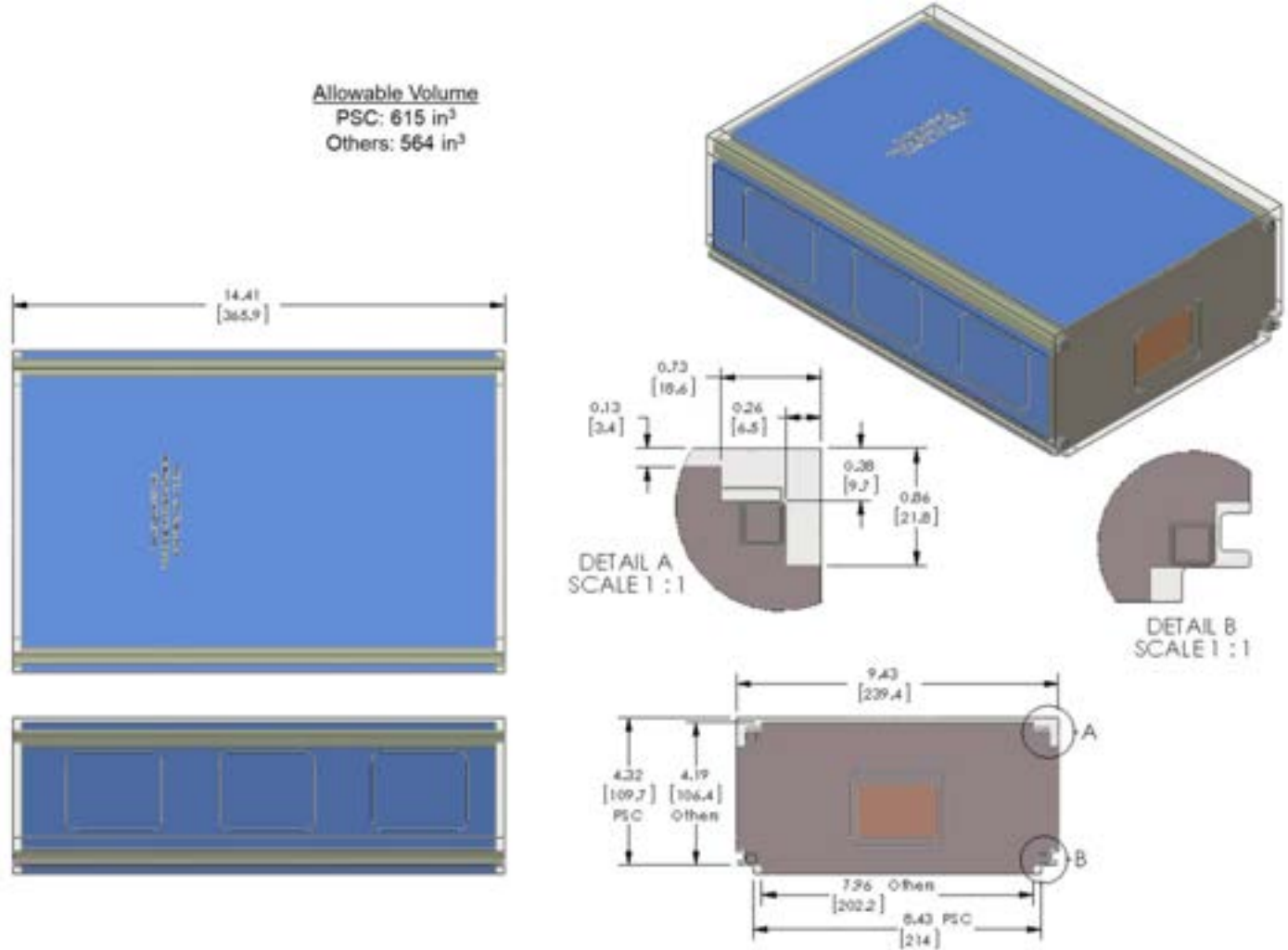

Figure 19-2: Comparison of 6U Payload Volumes. The CSD allows 9% more payload volume.

20. OPERATION AND INTEGRATION

Payload installation and integration is quick and straightforward. The figures below demonstrate the ease of attaching the CSD to a launch vehicle. The numerous mounting surfaces with threaded and through holes eliminate the need for additional interfacing structures. Use a minimum of 4 fasteners, one at each corner, when attaching the CSD to adjoining structures. The exact fastener qty. required shall be determined to ensure no gapping or slipping between the CSD and LV interface. The payload may be installed either before or after the CSD has been attached to the LV interface. Operating the door (either electrical or manually) after installation and verifying reliable dispensing of the payload is essential to ensure proper operation in the final flight configuration. PSC document 3000257 *CSD Operating and Integration Procedure* (ref. 13) shall be used for all payload installations, CSD operations, and launch vehicle integration. Further, only trained personnel shall use the CSD. See section 29 for details.



Figure 20-1: Installing 6U payload in CSD

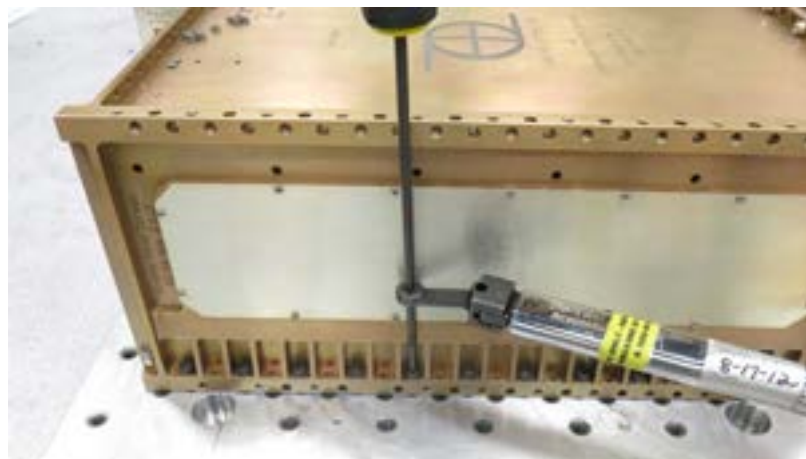

Figure 20-2: Using thru holes to mount CSD via -Y face



Figure 20-3: Using reduced clicker head wrench to torque fasteners via -Z face



Figure 20-4: Installing CSD initiator electrical harness

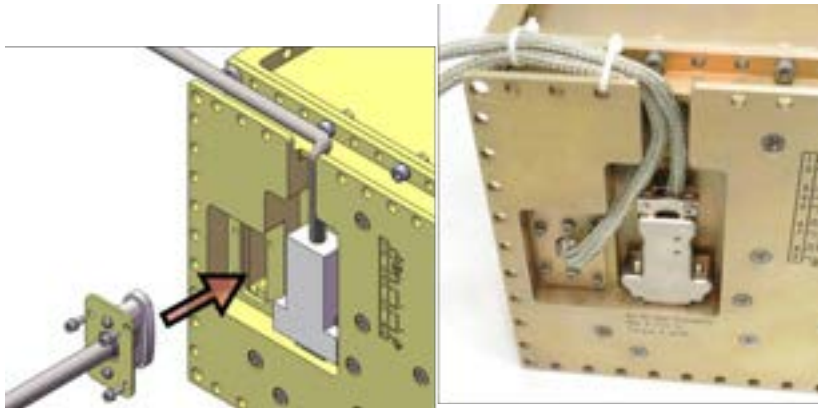

Figure 20-5: Installing LV side Separation Connector

21. CSD CONSTRAINED DEPLOYABLES

The CSD is capable of constraining deployables. Document 2002367 Payload Specification (ref. 3) provides details on allowable contact locations of deployables to the inside of the CSD. The distance from the payload maximum envelope to the walls can vary between .03 to .07 inches for the +/-X faces depending on the width of the payload tab. This is due to the necessary gaps in the X-axis between the tabs and the CSD. If a deployable is located on the -Y payload face, a small rotation rate will be imparted on the payload during ejection as the deployable contacts the door.

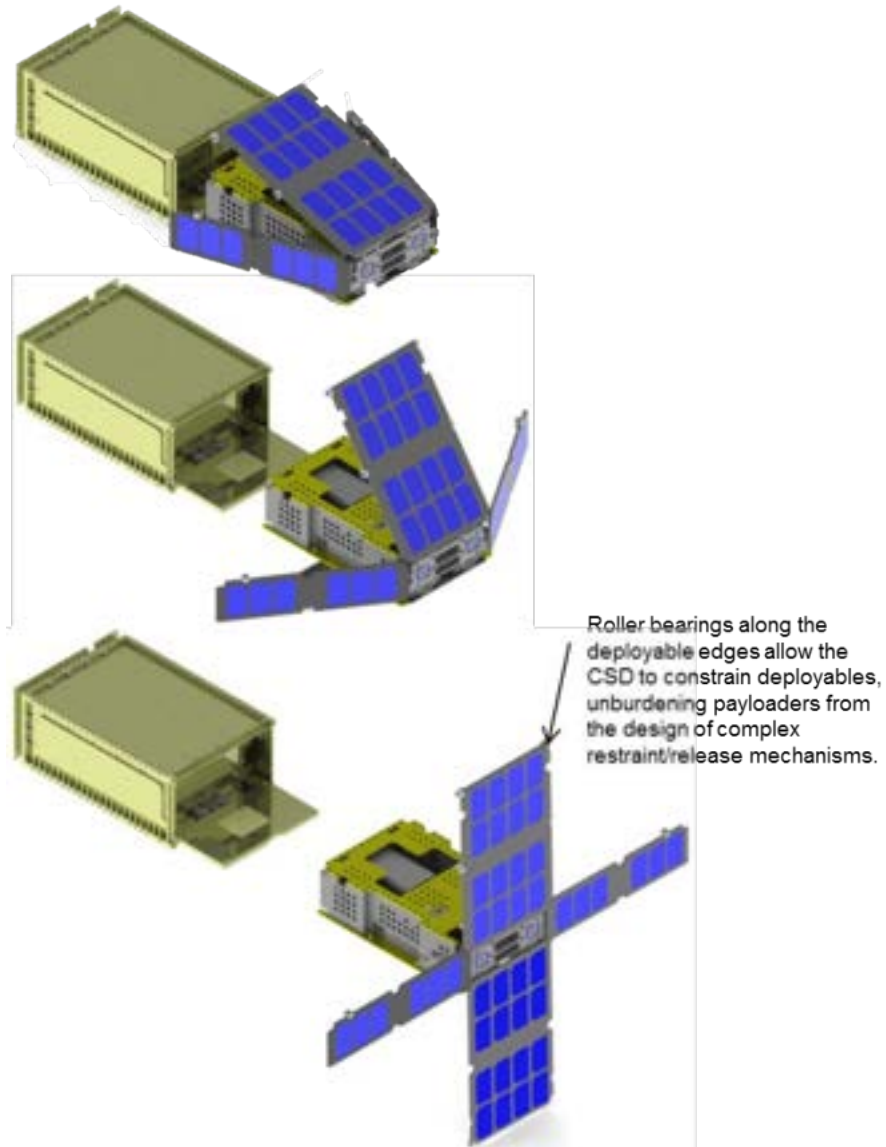

Figure 21-1: A 6U payload ejecting from the CSD

22. FASTENING PAYLOAD TO EJECTION PLATE

To facilitate hosted payloads, the payload can be permanently bolted to the CSD's Ejection Plate in the 6U or 12U. In addition, the Ejection Plate and payload can be fastened to the rear of the CSD. When the CSD initiates, the door opens and the payload either remains in the CSD or fully deploys but remains attached to the CSD. The latter is beneficial to increase aperture or field of view or deploy antennas or solar arrays. The payload can remain electrically connected to the host via a flexible harness.

The simplified CAD models of the CSD show the location of these attachment holes on the Ejection Plate.

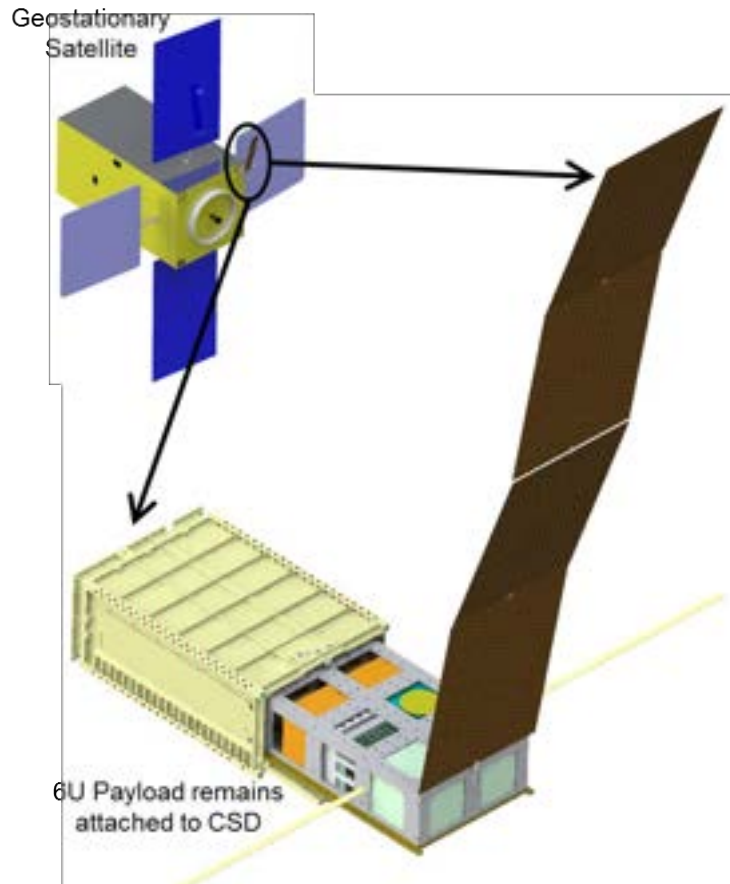

Figure 22-1: Payload remains attached to CSD to facilitate hosted payload usage

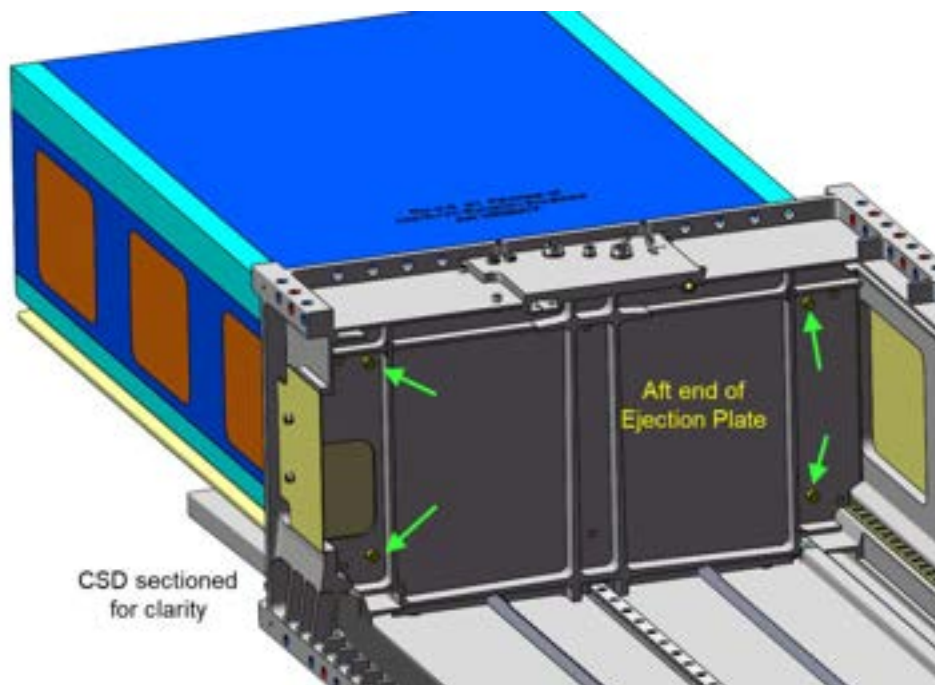

Figure 22-2: Payload permanently fastened to CSD's Ejection Plate via 4X .112-40 SHC screws

Figure 22-3 and Figure 22-4 detail the mounting holes to permanently attach a payload to the CSD.

- 1) **Thru holes:** Secure payload to Ejection Plate by installing .112-40 UNC fasteners from aft side of Ejection Plate. Upon initiation the CSD's door will open and the Ejection Plate will deploy. The payload will protrude from the CSD but remain fastened to the Ejection Plate. A flexible umbilical could maintain electrical connection to the LV.
- 2) **Threaded holes:** Attach the payload to the CSD via the .112-40 UNC holes. The threaded holes are part of the CSD -Z structure (Back Plate). Upon initiation the CSD's door will open but the payload will not move. The payload will remain inside the CSD and the Separation Connector will remain mated.

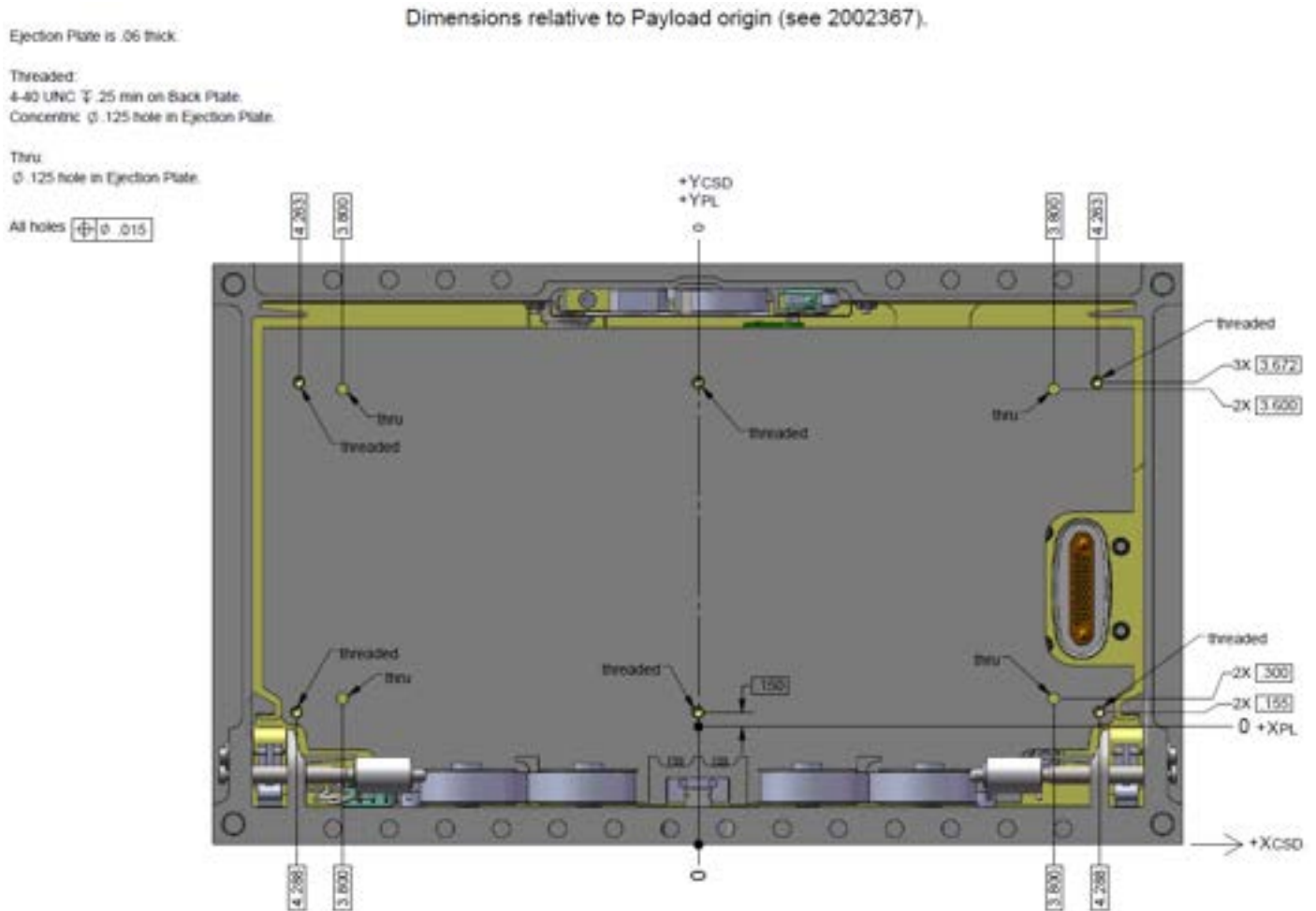

Figure 22-3: Payload mounting holes to CSD Ejection Plate or Back Plate, 6U

23. REDUCING DYNAMIC LOADING ON PAYLOAD

The CSD rigidly grips the payload's tabs, creating a direct load path from the launch vehicle to the payload. To reduce these potentially harmful LV induced vibratory and shock loads the use of an isolation system is strongly recommended. PSC has tested several isolation systems. These include commercial isolators as well as spaceflight specific isolators from MOOG CSA Engineering. All isolators tested to date drastically reduced the random vibration response and shock acceleration. The substantial benefits to the payload include increased allowable payload mass and reduced fatigue loading of sensitive components. PSC does not offer an isolation system as a product. The figures below show the significant reduction in loading during random vibration and shock testing.

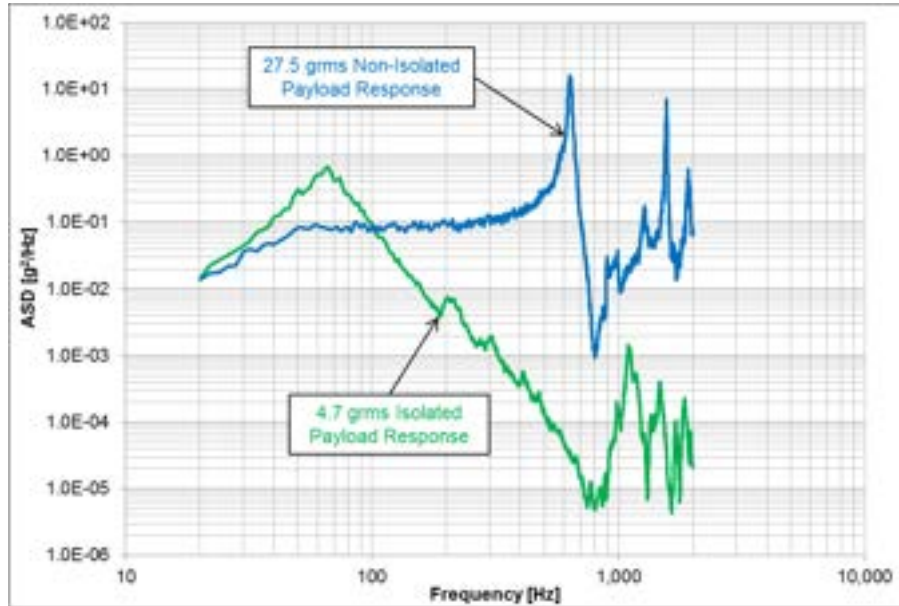

Figure 23-1: Isolation system benefits during random vibration testing

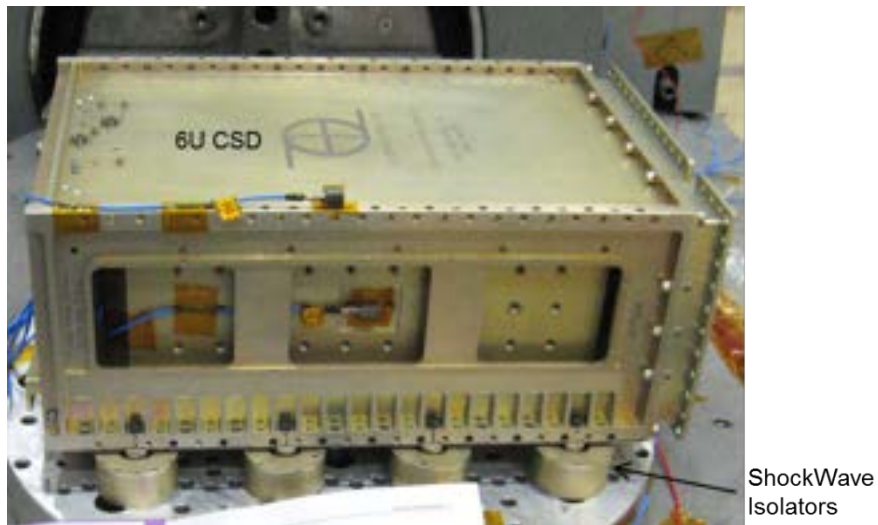

Figure 23-2: 6U CSD vibration test with Moog CSA ShockWave isolators

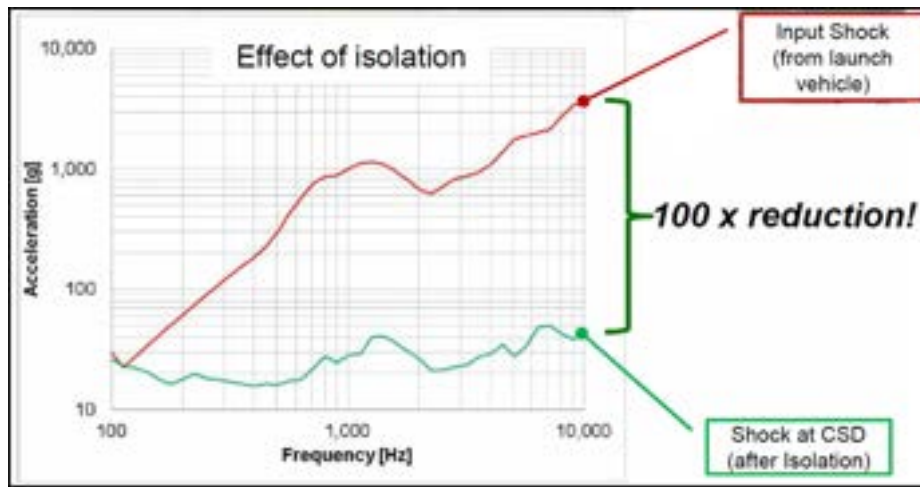

Figure 23-3: Isolation benefits during shock testing

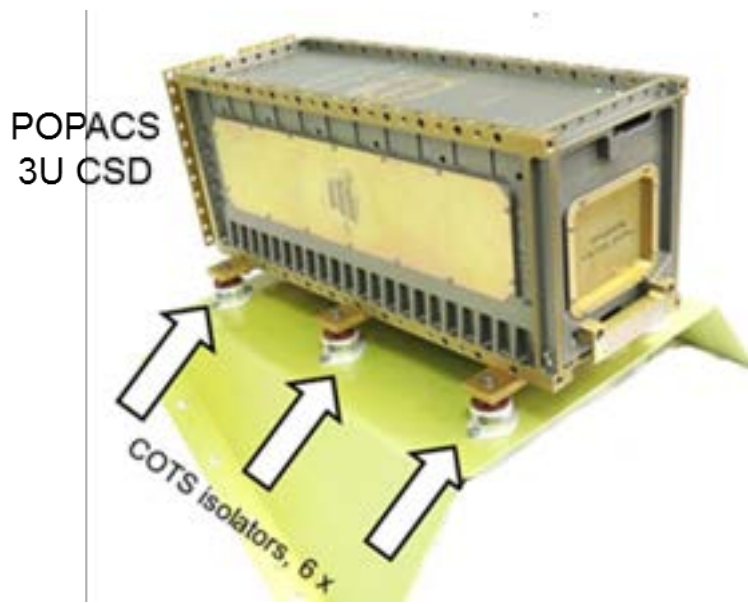

Figure 23-4: COTS isolators used on POPACS mission

24. CSD APPLICATIONS

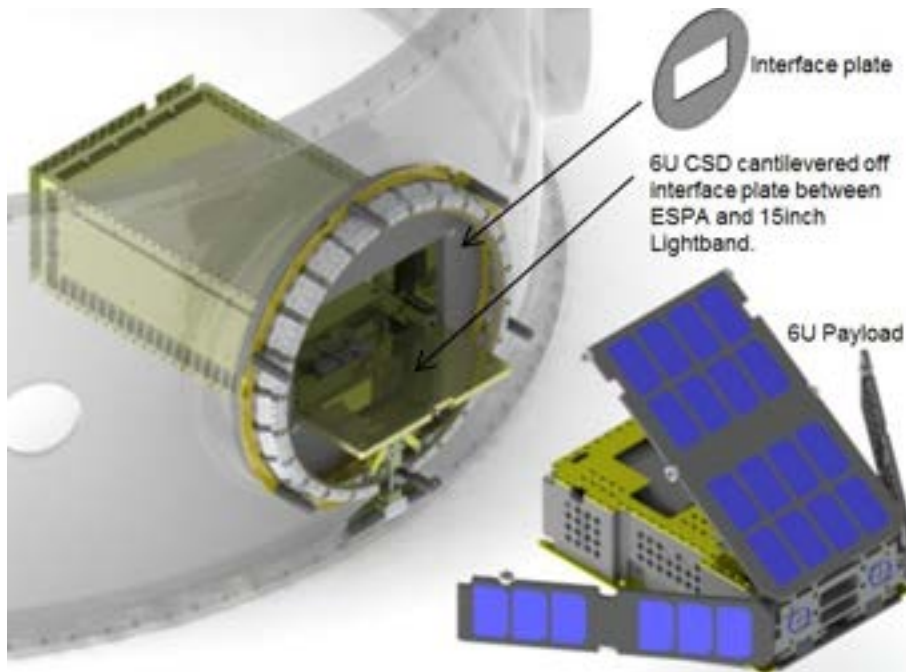

Figure 24-1: 6U payload deploying through ESPA port. CSD mounted directly via +Z face.

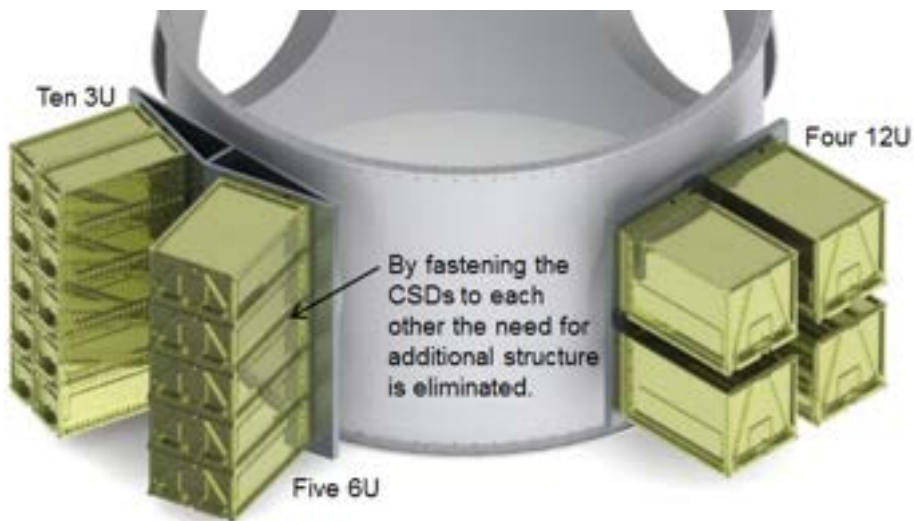

Figure 24-2: CSDs mounted to ESPA Grande

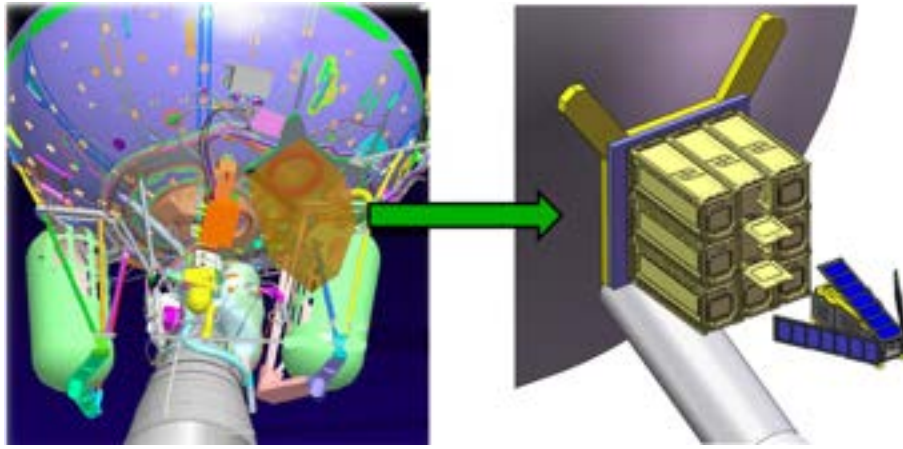

Figure 24-3: Nine 3U CSDs mounted to Atlas V Aft Bulkhead Carrier (ABC) via simple lightweight and low cost isogrid plate

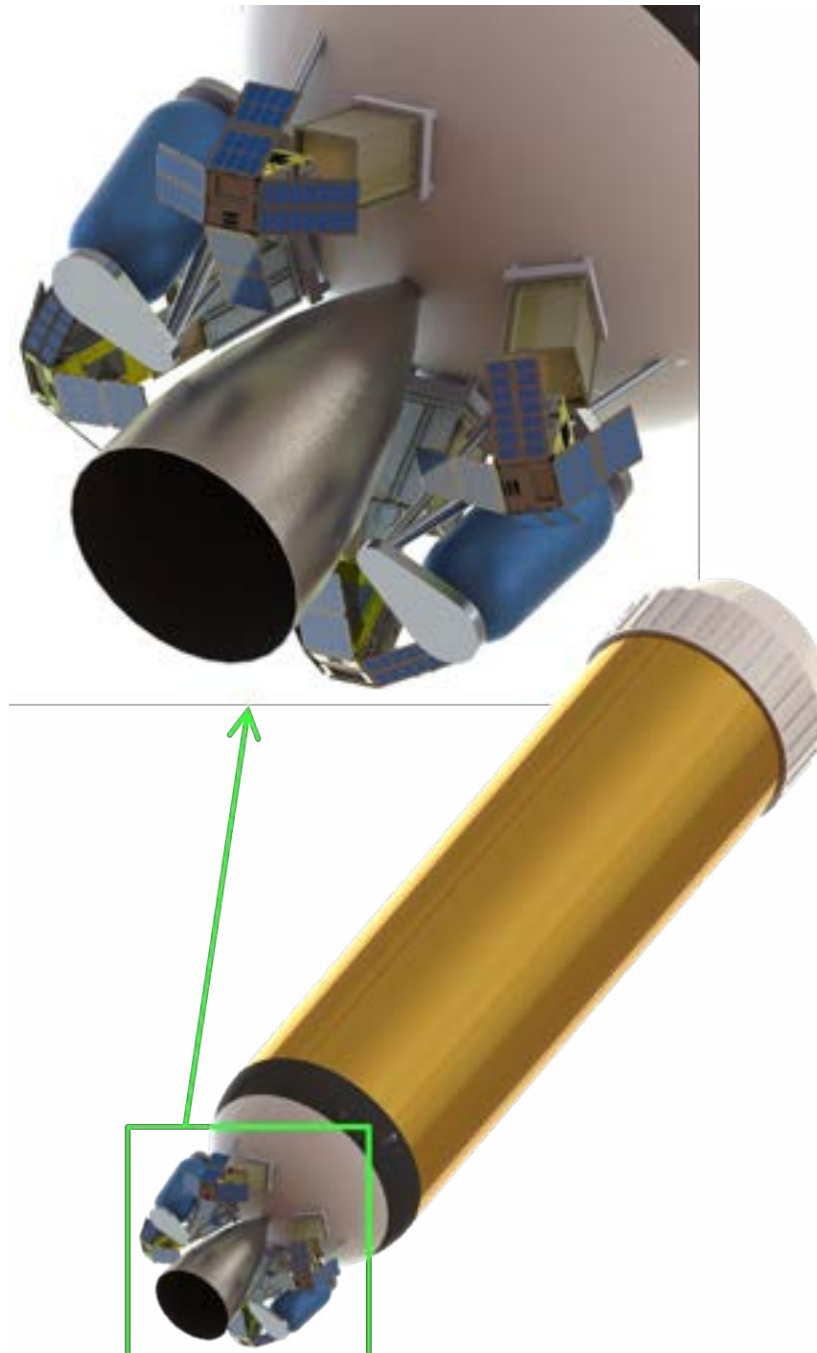

Figure 24-4: Four 12U CSDs on aft of stage

CSDs can dispense hosted payloads from large spacecraft. The separation connector enables trickle charging, thermal control and state-of-health telemetry for days, months, or years.

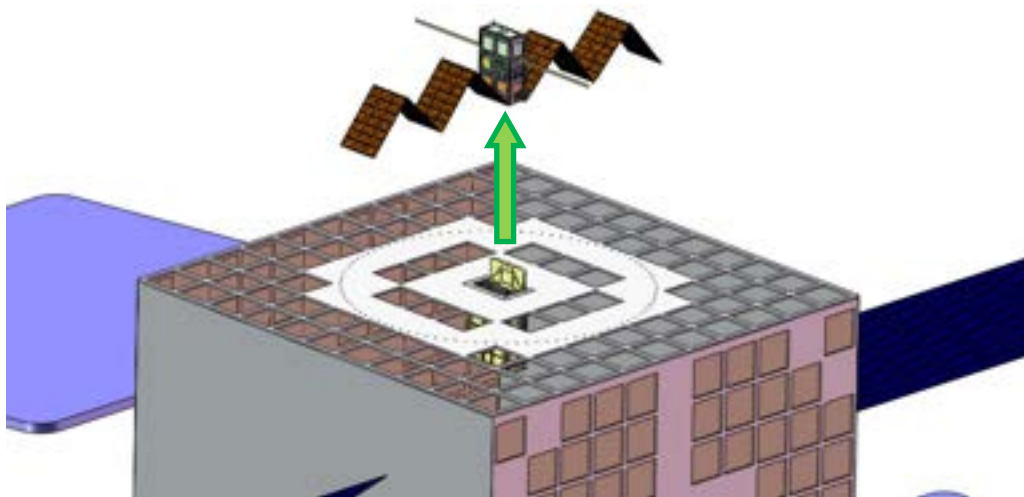
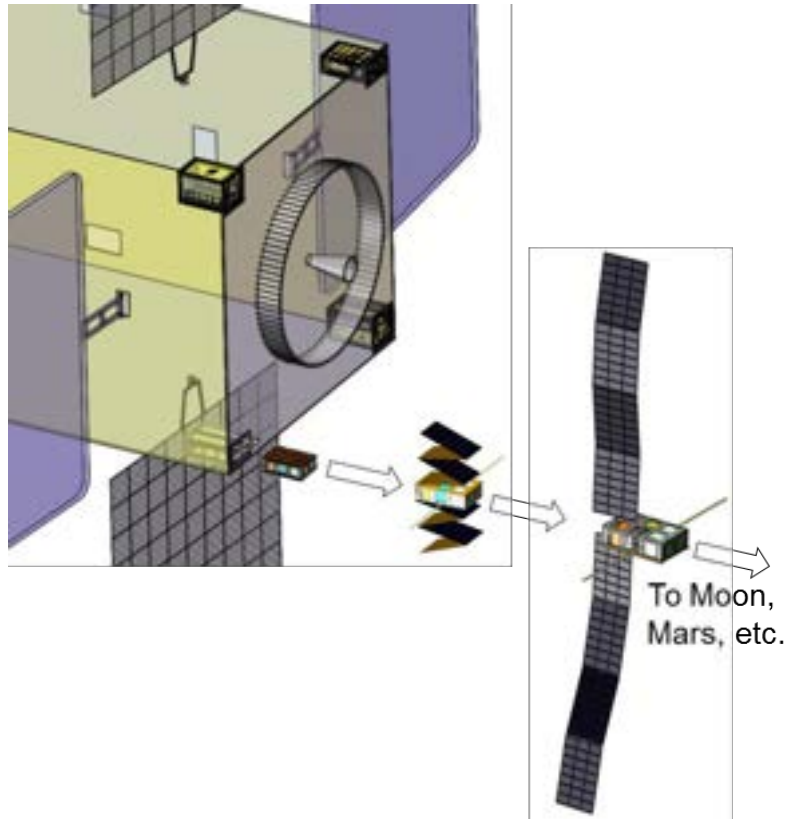

Figure 24-5: CSDs as hosted payloads

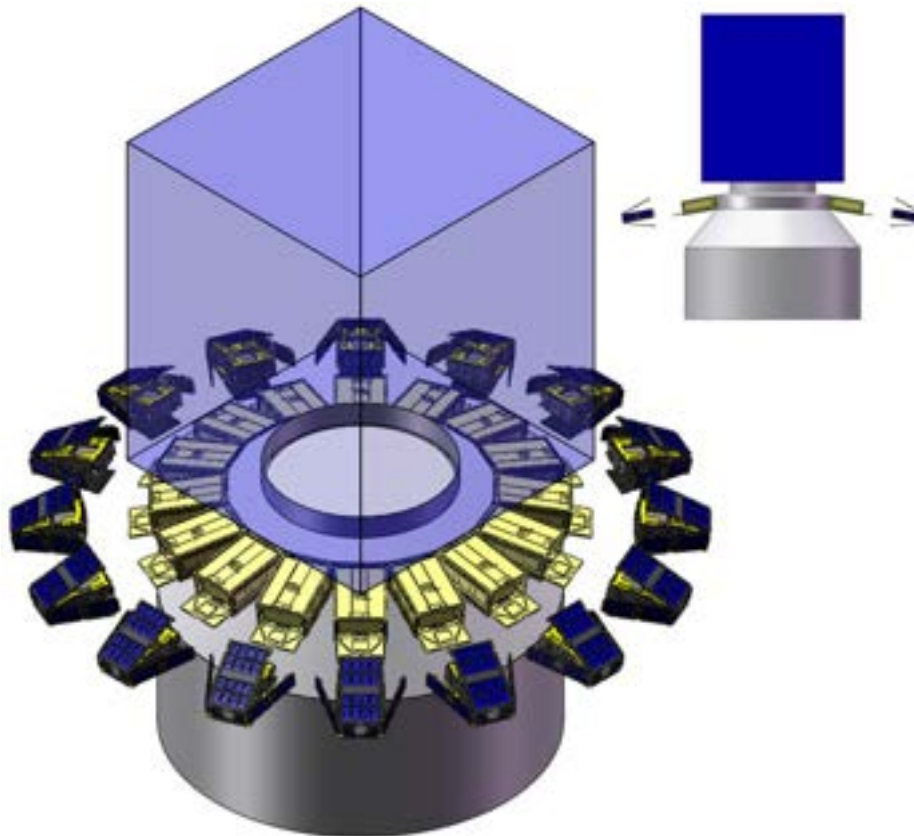

Figure 24-6: Sixteen 6U CSDs mounted underneath primary payload

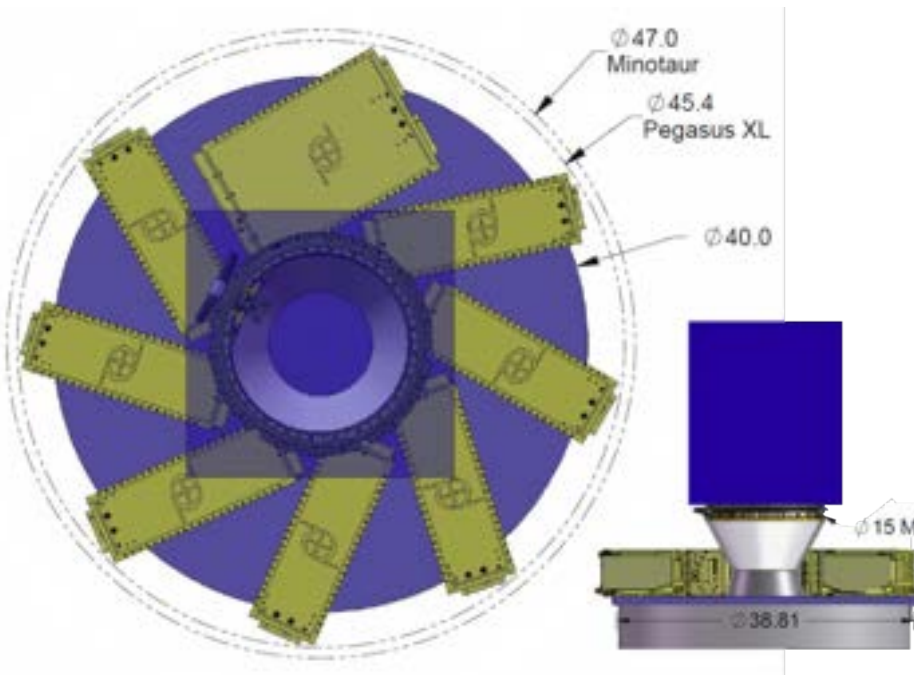

Figure 24-7: CSDs on plate with 15 inch Lightband

The CSD can be used as a sequencer to initiate multiple CSDs via a single LV signal. The sequencer 'payload' contains all batteries and electronics thereby reducing the burden on the LV and facilitating launch opportunities. It can also contain a camera to record the separation events.

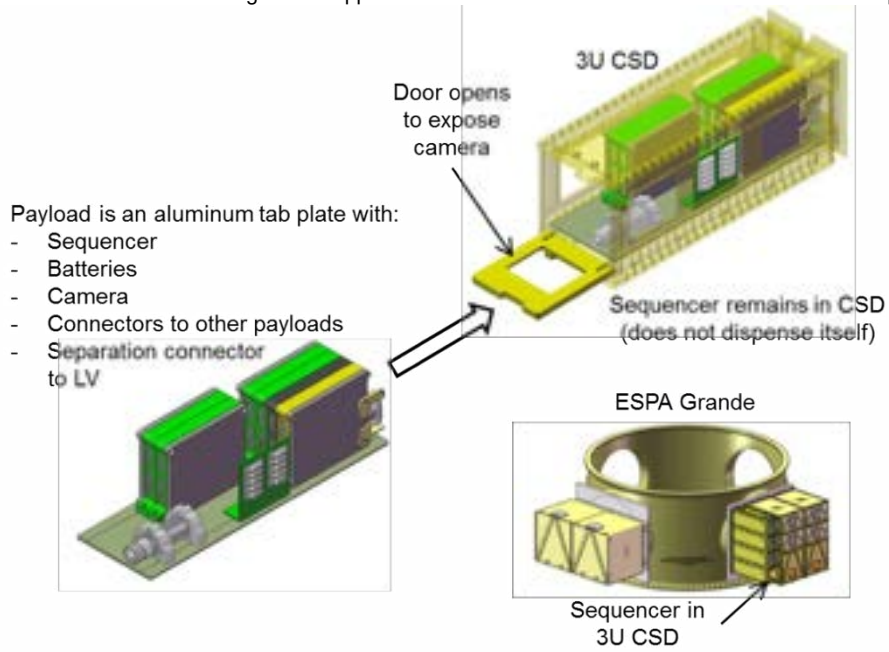

Figure 24-8: Using the CSD as a payload launch sequencer

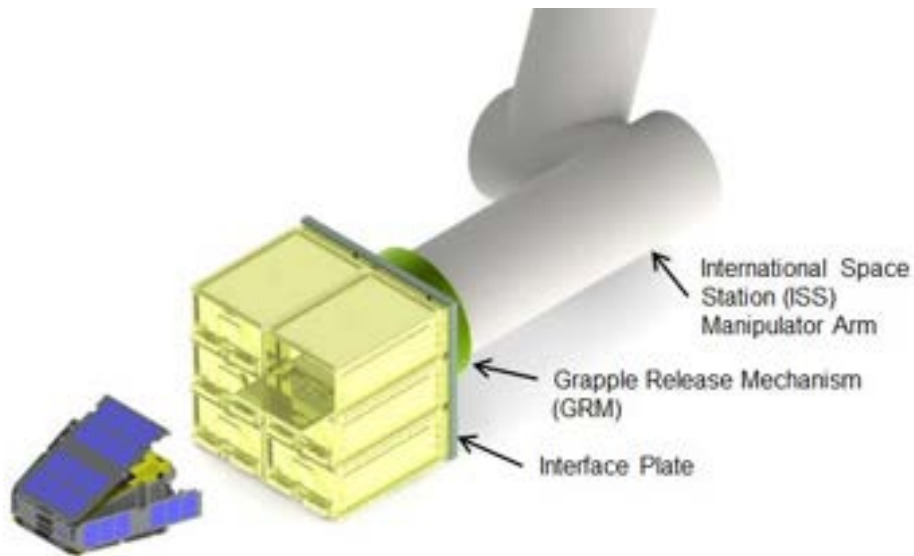

Figure 24-9: ISS manipulator arm dispensing six 6U payloads

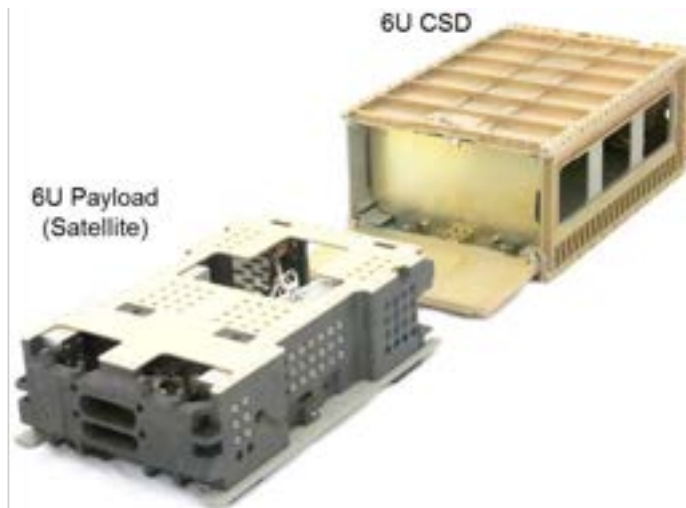

Figure 24-10: 3D printed payload dispensing from 6U CSD

The CSD can accommodate multi-piece payloads. Each discrete payload remains rigidly clamped via the tabs. The payloads need not occupy the entire length of the CSD (requires a custom matched CSD).

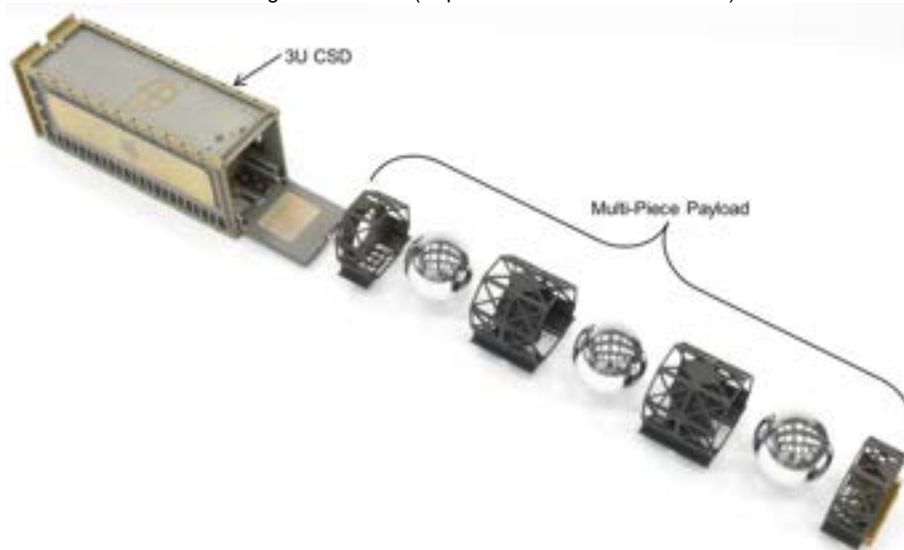

Figure 24-11: A single CSD can dispense multiple payloads (ref. 2, 6)

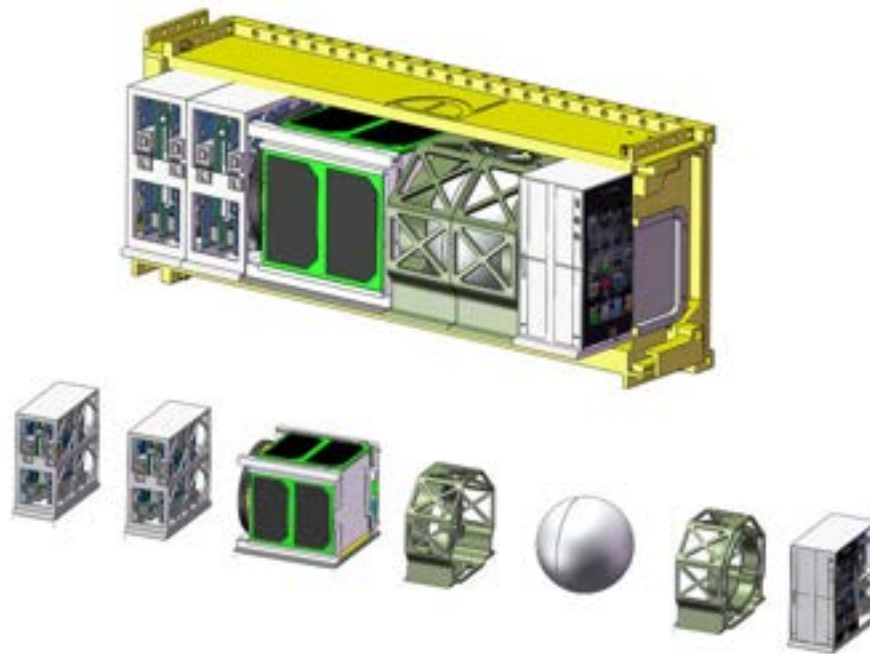

Figure 24-12: Multiple payloads in a CSD

The ability to mount CSDs to any face maximizes launch opportunities and simplifies integration. Figure 24-13 demonstrates the ability to mount CSD's to each other to maximize LV packaging density. Notice the open doors do not interfere with adjacent CSDs ability to deploy.



Figure 24-13: Five CSDs stacked on a single mounting plate



Figure 24-14: CSD mounted via -Y and +Y faces

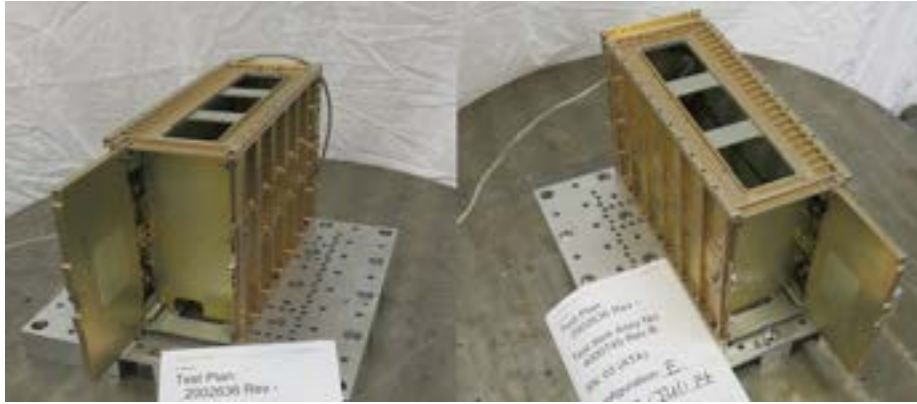

Figure 24-15: CSD mounted via -X and +X faces



Figure 24-16: CSD mounted via -Z and +Z faces

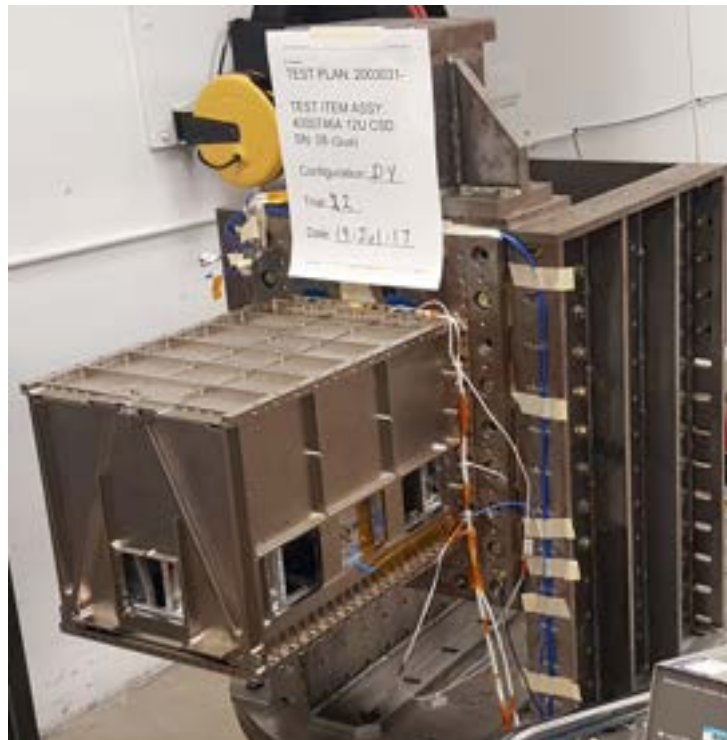

Figure 24-17: 12U mounted via -Z face for shock testing

The CSD can accommodate existing CubeSats. Fastening custom tabs to an existing CubeSat allows for seamless integration into the CSD (see Figure 24-18). PSC does not sell these custom tabs.

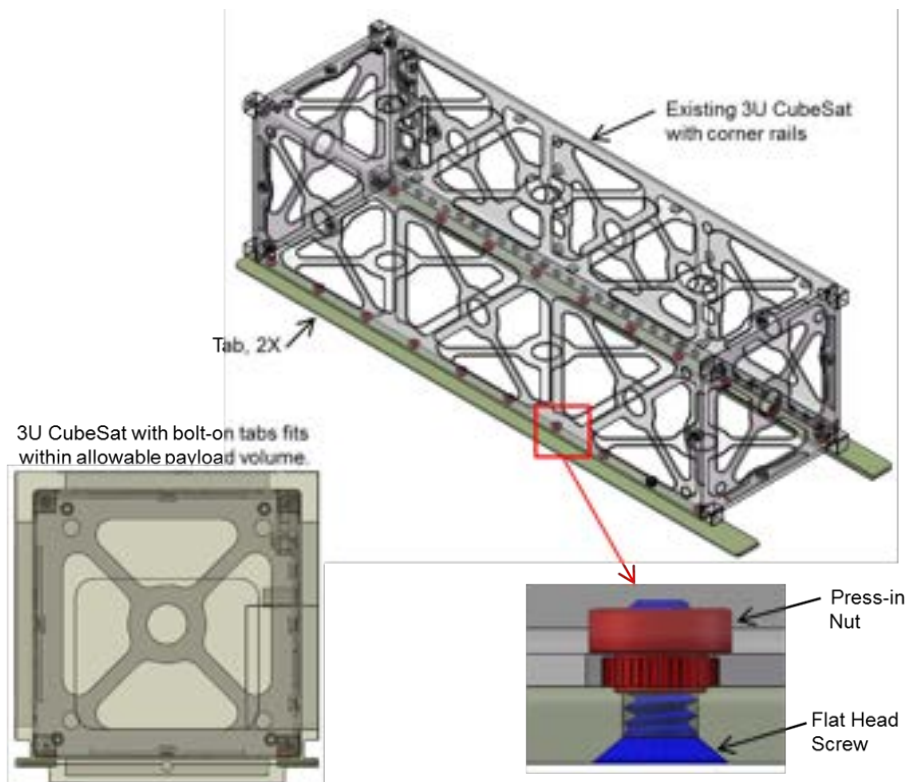

Figure 24-18: 3U CubeSat with bolt-on tabs

A Lightband separation system can be used in lieu of a CSD when the size of the payload renders canisterization impractical or the payload exceeds the allowable CSD volume.

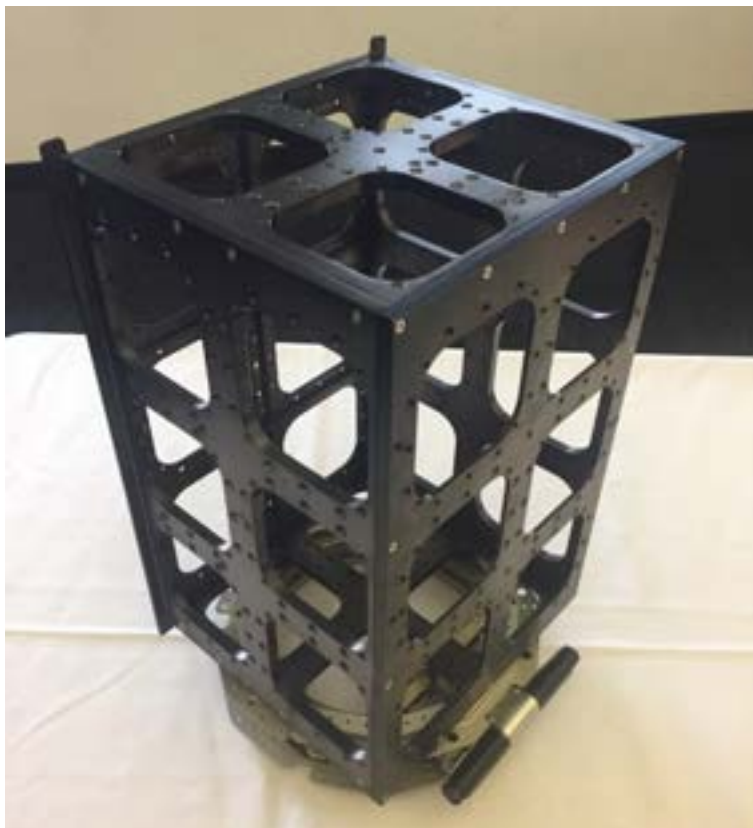

Figure 24-19: An 8 inch diameter Lightband used to separate a 12U payload

The CSD's flat external surfaces and numerous mounting holes simplify addition of auxiliary features like thermal blankets, radiation shielding, redundant door restraint, solar cells, video cameras, etc.

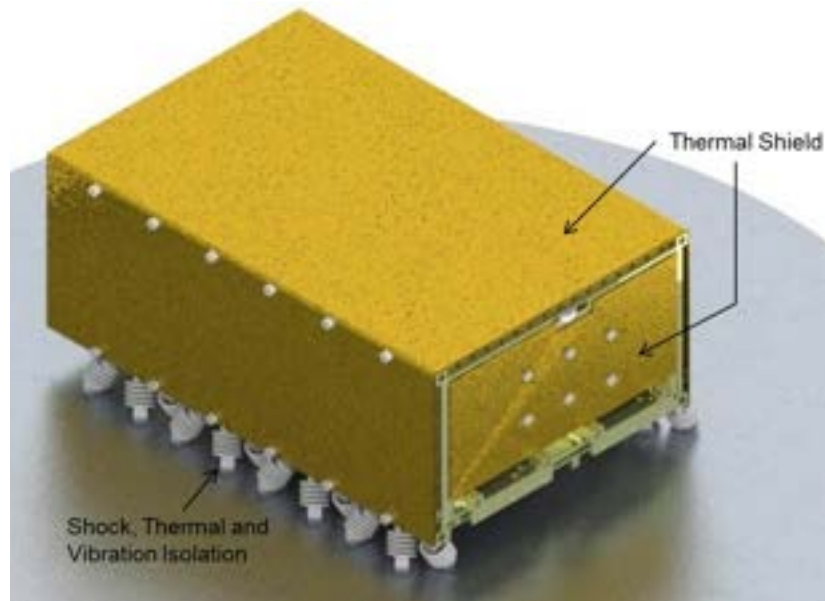

Figure 24-20: CSDs easily accept bolt-on vibration and thermal isolation

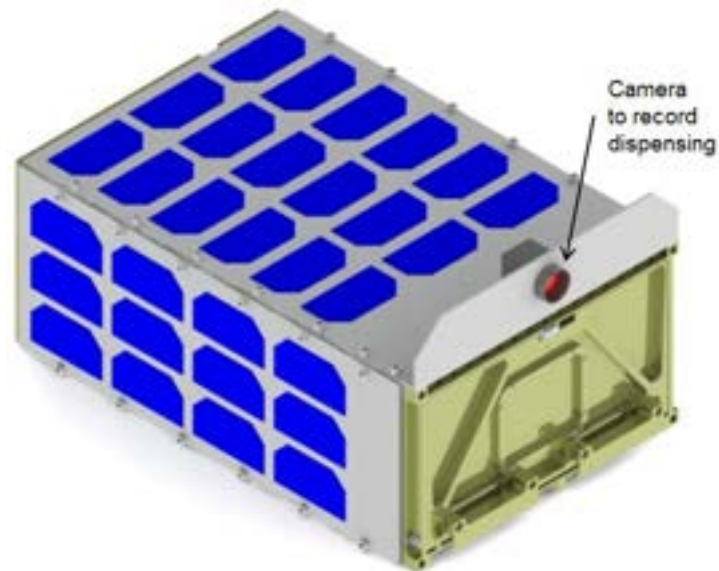

Figure 24-21: Adding auxiliary equipment to the CSD

25. TEST SUPPORT EQUIPMENT

PSC is pleased to share the Information in this section for purposes of edification. This Information and associated equipment are not supported by PSC. PSC makes no warranty or representation (express or implied, statutory or otherwise) as to the accuracy or completeness of any Information disclosed in this section. PSC shall have no liability to the Receiving Party or any of its Representatives or any third party arising from the use by the Receiving Party of the Information provided in this section.

Payload Separation Conveyor

Verifying full separation of the payload from the CSD is the only way to develop complete confidence in proper operation. For all testing PSC employs a custom conveyor mechanism that allows the payload to fully eject by rolling on ball bearings. This is not available for sale but PSC can provide a CAD model of the components from which the customer can design and manufacture their own.

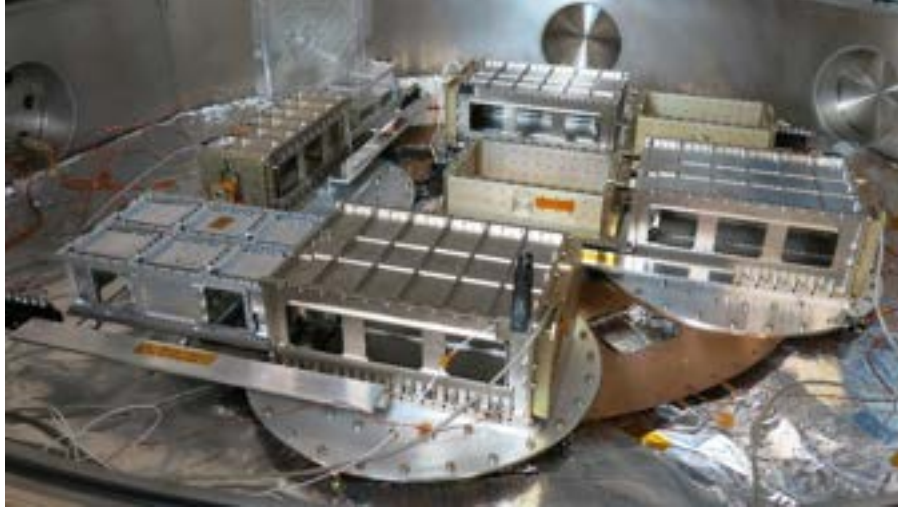

Figure 25-1: Four CSDs dispensing payloads onto conveyors in TVAC

Payload Vibration Fixture

Component level vibration testing of the payload prior to delivery of the CSD is often desired. The figures below show a means of simulating the CSD's interface to the payload tabs. Some customers have successfully used this fixture design but PSC has never built or tested it. PSC does not offer this for sale or provide production drawings. A solid model is available upon request.

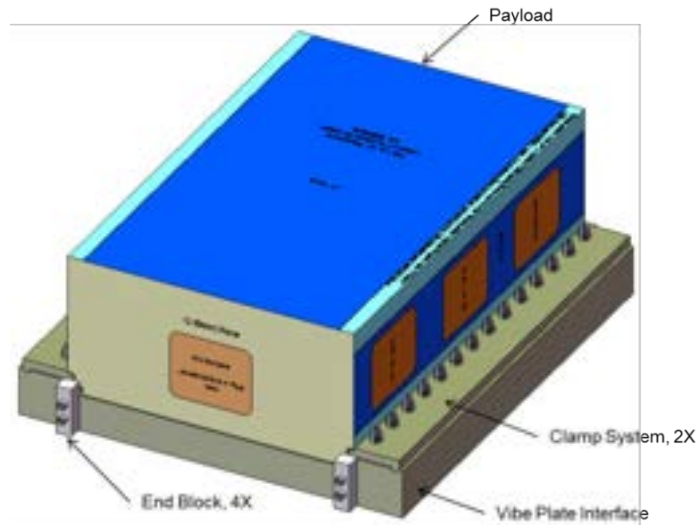

Figure 25-2: Vibration clamp overview

The top and bottom clamps should be aluminum alloy 6061-T6 with surface finish electroless nickel per ASTM B733-15, type IV. The preload (clamping normal force) shall be approximately 4,000 lbf per tab (8,000 lbf total).

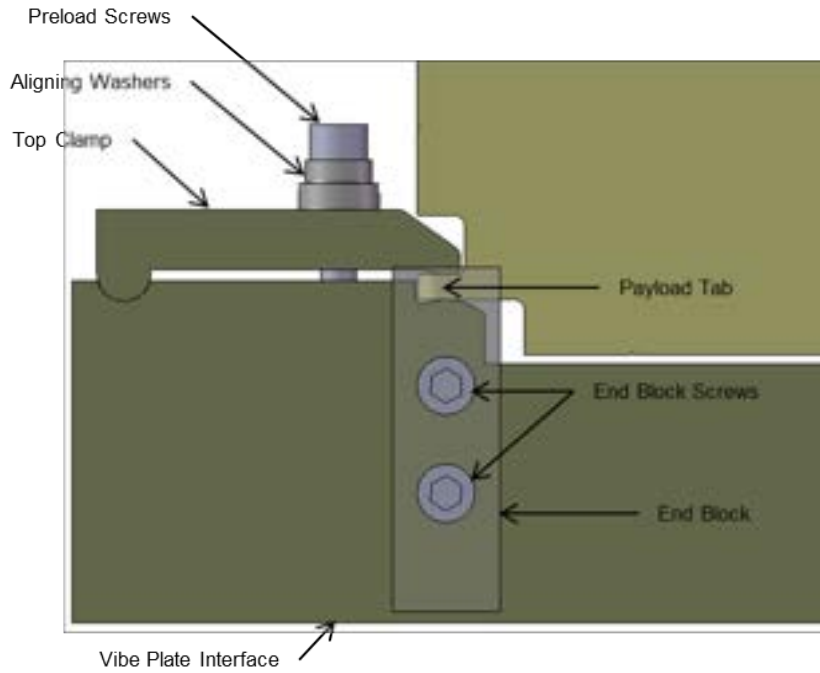

Figure 25-3: Clamp section view

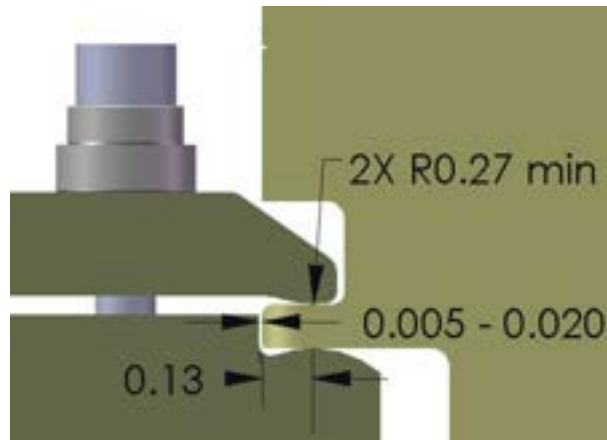
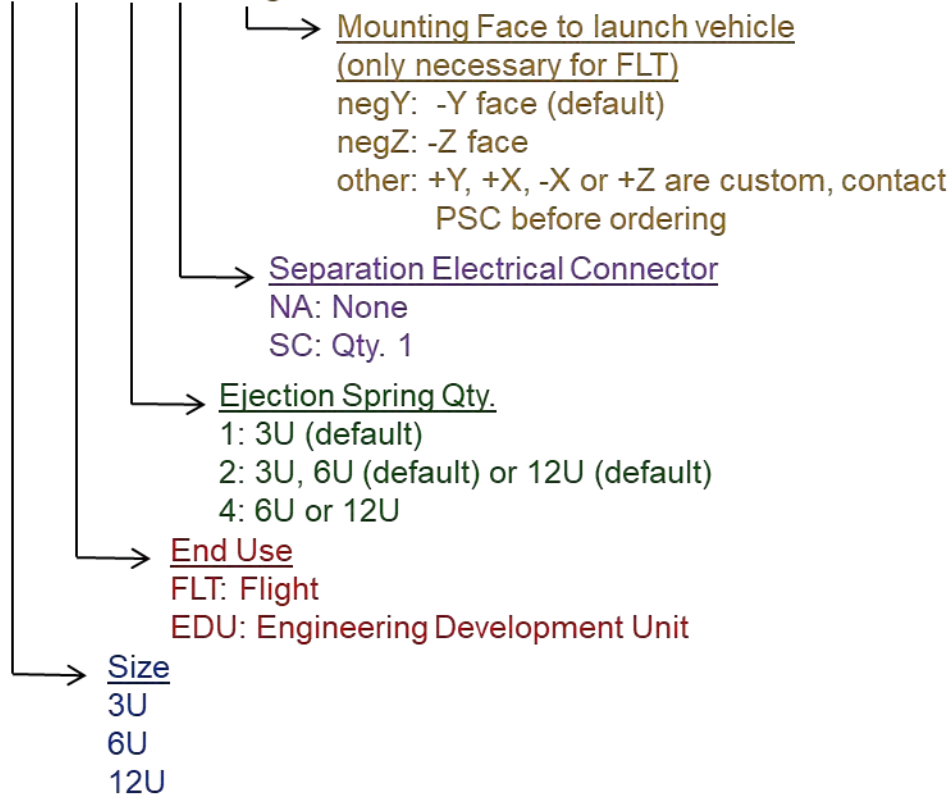

Figure 25-4: Contact details (dimensions in inches)

26. SPECIFYING AND ORDERING

When ordering a CSD specify the exact configuration using the following system. Mounting the CSD via the -Y face is standard. Mounting via the -Z face is also common but may increase cost. Mounting via any other face is considered custom and may incur additional cost and lead time.

Example: 6U-FLT-2-SC-negY



EDUs will be indelibly marked "NOT FOR FLIGHT".

27. TYPICAL LEAD TIME

The typical lead-time for a standard (non-custom) CSD is 36 weeks ARO. An accelerated lead-time may be possible at additional cost.

28. COST

For the most up to date prices please contact PSC directly. Due to the time savings and reliability inherent to the CSD, the total cost of ownership is lower than comparable dispensers. A payload can be deployed from the CSD, re-loaded, and ready for another deployment in a matter of minutes, greatly reducing the time and cost per operation during test. Further, the CSD easily interfaces to adjoining structures greatly reducing the time and cost of integration.

Table 28-1: CSD benefits

Item	CSD	Other Dispensers
Verify full separation (ejection) of the payload from the dispenser during test.	✓	
Quickly reset initiator after TVAC test without refurbishment.	✓	
Quickly reset initiator after vibration test without refurbishment.	✓	
Eliminate need for adapter plate or access to bottom of dispenser during integration.	✓	
Remove/swap satellites from dispenser after installation on LV without disturbing stack or refurbishing initiator.	✓	
Package dispensers densely and/or stack them to maximize revenue per launch dollar.	✓	
Safe/arm satellite via door on densely packed LV where there is no access to sides of dispenser.	✓	
Predict failure modes, like fatigue, via accurate dynamic modeling prior to build, test and launch.	✓	

29. TRAINING

Training is required prior to installing a payload, operating the CSD or integrating. Failure to obtain training prior to this will void the warranty. Training is offered at PSC with the purchase of a CSD.

30. RELIABILITY

Probability of Success	Confidence Level [%]
>0.999	60
>0.998	85
>0.997	95
>0.996	97.5

Table 30-1: Minimum reliability and corresponding confidence level

Table 30-1 was calculated using Table 22.4 of *Space Vehicle Mechanisms* by Peter L. Conley given approximately 1,000 no failure tests. CSDs have cumulatively been operated more than 3,000 times during production, testing and flight operations. There have been no failures to operate in testing at published environments.

Prior to spaceflight, each CSD is separated numerous times to verify operability. These include operations conducted during acceptance testing by PSC and additional operations performed by the customer. As shown in Table 30-2, the CSD allows the user to verify operation multiple times before flight. Further, the CSD is the only dispenser that enables complete separation of the payload during ground testing. This is essential for verifying total functionality. Only allowing the door to open does not fully verify the dispenser.

	Competing Dispensers	CSD
Typical quantity of operations on non-refurbished flight unit	≤1	≥17

Table 30-2: Comparison of dispenser operations before launch

PSC tests development and qualification units to examine reliability limits and inform the allowable limits of CSDs in ground test and space flight. A typical qualification campaign will result in more than 100 separation tests on a single CSD. In fact the three current qualification CSDs each have over 300 operations. The initiation electrical telemetry for every operation is recorded on PSC's data acquisition systems.

Because of the reusability of the CSD and the high production rate, it has been inexpensive to amass test data that is several orders of magnitude larger than competing systems. The CSD was designed to be reusable with the intent of demonstrating reliability.

Maximum reliability of the CSD can be attained by minimizing the power conducted into the CSD and the number of cycles. Specifically, minimize applied voltage levels as higher voltages will put more power into the mechanism. More power increases stresses to the initiator components. Minimizing durations is also beneficial as it reduces unnecessary cycles on the mechanism.

PSC constantly advances the CSD technology to increase reliability during ground test and in flight. By building and testing several CSDs per month, PSC engineers are made aware of trends that may compromise reliability.

31. FAILURE MODES AND EFFECTS ANALYSIS

A detailed failure modes and effects analysis (FMEA) has been performed for the CSD in PSC document 2003138. Contact PSC for more info. The CSD's reusability enables significant testing and the accumulation of thousands of operations to expose design weaknesses which can then be corrected. These operations are several orders of magnitude greater than competing dispensers. Obtaining this amount of knowledge with other technologies would be prohibitively expensive and time consuming.

Further, PSC has simulated failures by purposely removing or damaging components and operating to examine the affect. Table 31-1 summarizes the failures simulated in a 12U CSD (PSC test 2003198-). All operations were performed in PSC's thermal vacuum chamber at pressure <1.0E-4 Torr.

Table 31-1: 12U CSD failure simulations

Cfg.	Op.	Door Torsion Spring Removed?	Preload Stick Compression Spring Removed?	Two Ejection Springs Removed?	Latch Extension Spring Removed?	Preload Stick Bearings Seized?	FOD in Linear Way Bearing?	Temp. [°C]	Complete Payload Separation?
A	1	Yes	Yes	Yes (asymmetric)	Yes	No	No	20	Yes
	2	Yes	Yes	Yes (asymmetric)	Yes	No	No	-45	Yes
	3	Yes	Yes	Yes (asymmetric)	Yes	No	No	75	Yes
	4	Yes	Yes	Yes (asymmetric)	Yes	No	No	20	Yes
B1	5	Yes	Yes	Yes (asymmetric)	Yes	Yes	No	20	Yes
	6	Yes	Yes	Yes (asymmetric)	Yes	Yes	No	-45	No (1)
B2	7	Yes	Yes	Yes	Yes	No	Yes	20	Yes
	8	Yes	Yes	Yes	Yes	No	Yes	-45	Yes
	9	Yes	Yes	Yes	Yes	No	Yes	75	Yes
	10	Yes	Yes	Yes	Yes	No	Yes	20	Yes

1) Shims (used to seize the Preload Stick bearings) loosened and stopped the payload midway through ejection.

32. STORAGE REQUIREMENTS

Store the CSD in a sealed enclosure in relative humidity of less than 95% (non-condensing) at temperatures from 0 to 50°C. PSC should be contacted prior to operation if any of the maximum allowable storage durations are exceeded.

Table 32-1: CSD allowable storage duration

CSD State	Max. Allowable Storage Duration [yrs]
No Payload	5
Payload Installed	1

33. TIPS AND CONSIDERATIONS

- 1) The ejection spring force is often much less than the payload weight. Installing a removable handle to the payload's +Z face aides vertical installation of the payload into the CSD.
- 2) When deploying horizontally in 1g the payload will fall during ejection. This will damage the payload's tabs as high forces are created near end of travel due to reaction of gravity induced moments. To avoid damage either guide the payload on rollers (conveyor) or prematurely stop it >3 inches early and then remove by hand.
- 3) As mentioned in section 22, the CSD Ejection Plate has a few small holes to assist hosted payloads. Obtain a CAD model of the CSD to ensure these holes do not interfere with the payload's inhibit switch locations.
- 4) CSD magnetic fields:
 - i. The CSD contains a small rare-earth magnet motor directly behind the Ejection Plate. The strength of the magnetic field is unknown.
 - ii. The CSD is comprised primarily of electroless nickel coated aluminum. The phosphorus content is typically 5 to 9% and therefore the coercivity is likely <30 Oe. See Ref. 14
- 5) The CSD has numerous .190-32 UNF threaded holes on the exterior surface that can be used to attach auxiliary features. They can also be used to attach lifting hardware. For example AN42B lifting bolts can easily thread into the CSD.



Figure 33-1: AN42B eyebolt

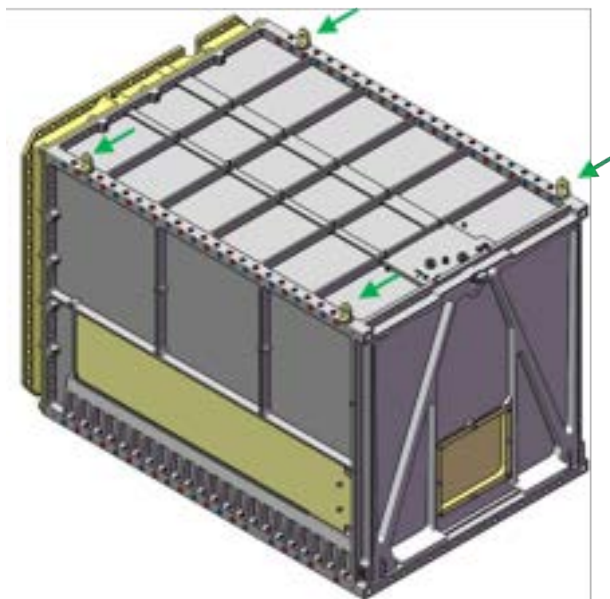

Figure 33-2: 12U CSD with eyebolts threaded in to corner rails for lifting

34. ACKNOWLEDGEMENTS

PSC thanks the following individuals (in no implied order) that have contributed to the current maturation of the CSD:

Dr. Andrew Kalman, Pumpkin Inc.	Adam Reif, Pumpkin Inc.
Shaun Houlihan, Pumpkin Inc.	Hans-Peter Dumm, AFRL
The late Steve Buckley, ORS	Dr. Jeff Welsh, formerly of ORS
Craig Kief, COSMIAC	Dr. Eric Swenson, AFIT
Philip Smith, AFIT	Dr. Jordi Puig-Suari, Tyvak
Roland Coelho, Tyvak	Dr. Robert Twiggs, Morehead State
Gil Moore, Project POPACS	Rex Ridenoure, Ecliptic Enterprises Corp.
Tom Walkinshaw, Pocketcubeshop	Bruce Yost, NASA AMES
Stephen Steg, Blue Canyon	Dustin Doud, formerly of SpaceX
Justin Carnahan, Tyvak	

35. CAD AND FINITE ELEMENT MODELS

Simplified CAD models of the CSD, in STEP format, are available at www.planetarysys.com. Finite element models (FEMs) are available by contacting info@planetarysystemscorp.com.

36. REFERENCES

- 1 Hevner, Ryan; Holemans, Walter, "An Advanced Standard for CubeSats", Paper SSC11-II-3, *25th Annual AIAA/USU Conference on Small Satellites*, Logan, UT, August 2011.
- 2 Holemans, Walter; Moore, Gilbert; Kang, Jin, "Counting Down to the Launch of POPACS", Paper SSC12-X-3, *26th Annual AIAA/USU Conference on Small Satellites*, Logan, UT, August 2012.
- 3 *Payload Specification for 3U, 6U, 12U and 27U*, 2002367 Rev D, Planetary Systems Corp., Silver Spring, MD, August 2016.
- 4 *Separation Connector Data Sheet*, 2001025 Rev C, Planetary Systems Corp, Silver Spring, MD, July 2013.
- 5 *CubeSat Design Specification*, Rev 12, California Polytechnic State University, CA, Aug 2009.
- 6 Hevner, Ryan, "Lessons Learned Flight Validating an Innovative Canisterized Satellite Dispenser", Paper 978-1-4799-1622-1/14, *2014 IEEE Aerospace Conference*, Big Sky, MT, January 2014.
- 7 Clark, Pamela; Holemans, Walter; Bradley, Wes, "Lunar Water Distribution (LWaDi)-- a 6U Lunar Orbiting spacecraft", *11th Annual Summer CubeSat Developers' Workshop*, Logan, UT, 02-03 August 2014.
- 8 Azure, Floyd; Hevner, Ryan; Holemans, Walter; Moore, Gil; Williams, Ryan, "Lessons Learned Testing and Flying Canisterized Satellite Dispensers (CSD) for Space Science Missions", *3rd Annual Lunar Cubes Workshop*, Palo Alto, CA, 13-15 November 2013.
- 9 Azure, Floyd; Hevner, Ryan; Holemans, Walter; Kalman, Andrew; Ridenoure, Rex; Twiggs, Robert; Walkinshaw, Tom; Williams, Ryan, "Innovative Uses of The Canisterized Satellite Dispenser (CSD)", *11th Annual CubeSat Workshop*, San Luis Obispo, CA, 25 April 2014.
- 10 Hevner, Ryan; Holemans, Walter; Williams, Ryan, "Canisterized Satellite Dispenser (CSD) as a Standard for Integrating and Dispensing Hosted Payloads on Large Spacecraft and Launch Vehicles", *30th Space Symposium*, Colorado Springs, CO, 21 May 2014
- 11 Azure, Floyd; Hevner, Ryan; Holemans, Walter, "Lessons Learned Measuring 3U and 6U Payload Rotation and Velocity when Dispensed in Reduced Gravity Environment", *12th Annual CubeSat Workshop*, San Luis Obispo, CA, 21 April 2015.
- 12 Azure, Floyd; Hevner, Ryan; Holemans, Walter, "Methods to Predict Fatigue in CubeSat Structures and Mechanisms", *12th Annual Summer CubeSat Developers' Workshop*, Logan, UT, 08-09 August 2015.
- 13 *CSD Operating and Integration Procedure*, 3000257 Rev B, Planetary Systems Corp, Silver Spring, MD, January 2016.
- 14 Parkinson, Ron, "Properties and Applications of Electroless Nickel", Nickel Development Institute

37. ADDITIONAL INFORMATION

Verify this is the latest revision of the specification by visiting www.planetarysys.com. Please contact info@planetarysystemscorp.com with questions or comments. Feedback is welcome in order to realize the full potential of this technology.

PSC does not design or manufacture payloads.

38. REVISION HISTORY

Revision	Release Date	Created By	Reviewed By
-	25-Jul-2012	RH	WH
A	6-Aug-2013	RH	WH
B	21-Jul-2014	RH	WH
C	3-Aug-2015	HM	WH
D	4-Aug-2016	RH	WH
E	4-Aug-2017	RH	WH
F	3-Aug-2018	RH	WH
G	23-May-2022	ML	WH

Changes from previous revision:

Section	Changes
2	- Corrected typo "DB-9" to "DE-9"
4	- Added PSC assembly number for CSDs - Added note for FEPs
5	- Updated with more details and clarifications
12	- Table 12-1: changed acceptance Tvac hot temp to 61 - Table 12-1: added note 5 - Replaced Figure 12-1 with broad TVAC parameters - Figure 12-3: removed sine sweeps and source docs
17	- Clarified that 800 lbf requirement is total response on both tabs.
26	- Updated pricing to match current
27	- Typical lead-time updated. - Removed Table 27-1